

USER'S MANUAL

Vidos

ACCESS CONTROL

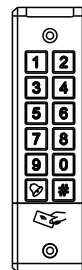

Mode: SZ32

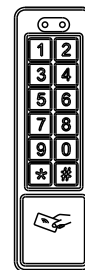

Mode: ZS52

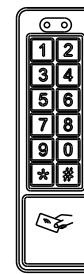

Mode: ZS82

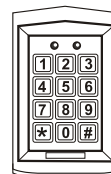

Mode: ZS10

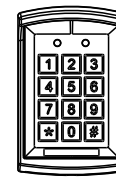

Mode: ZS30



Mode: ZS50

Vidos
friendly technology

Firma Handlowa Wena
Al. Jerozolimskie 311
05-816 Reguły, Poland
tel. +48 22 8370286; +48 22 8174008
e-mail: biuro@vidos.pl
www.vidos.pl

CE FC RoHS 

W.20190906ENG

Wiring Diagram

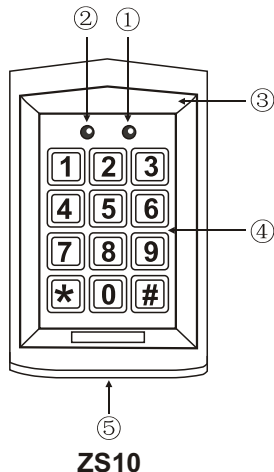
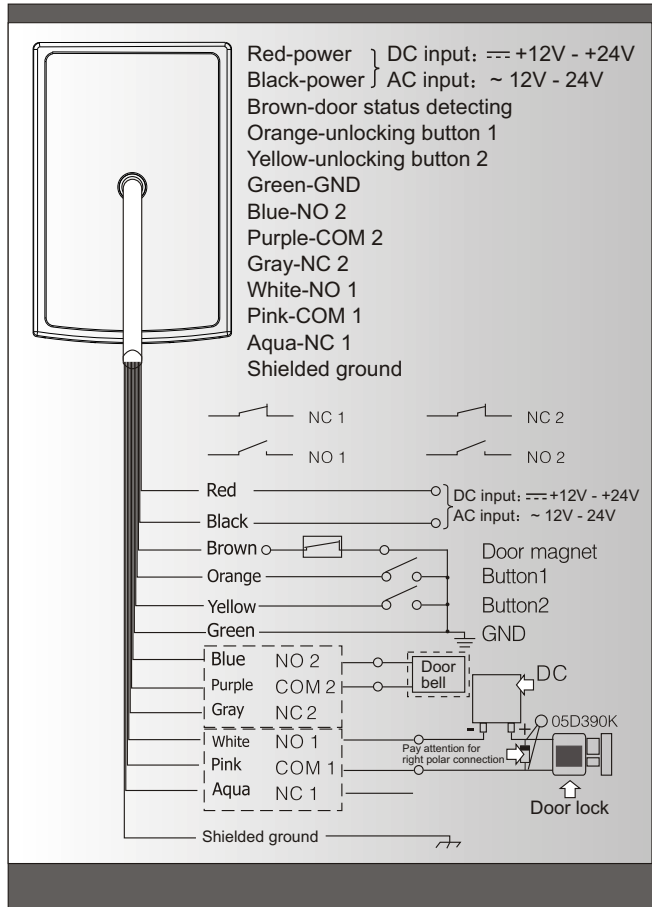

| NO. | Description |
|-----|----------------|
| ① | Mode indicator |
| ② | Door indicator |
| ③ | Antenna |
| ④ | Matrix keypads |
| ⑤ | Case screw |

Working conditions:

temperature: -20C ~ +50C
 RH: ≤95%

Current and voltage requirements:

DC input: --- +12V - +24V
 AC input: ~ 12V - 24V
 standby current: ≤80mA
 working current: ≤110mA

Applicable card mode:

EM ID card(Default)
 T5557/T5567 card(Setting required)

Effective distance: 5cm

Capacity:

ZONE 1: up to 1000 passwords & card holders
 ZONE 2: up to 10 passwords OR card holders

Specifications / Features

- With internal EM reader.
- Frequency: 125KHz.
- Effective distance: 5cm.
- ZONE 1: up to 1000 passwords & card holders.
 ZONE 2: up to 10 passwords OR card holders.
- Card access, code access and combined access.
- Digital keypad operation.
- Built-in pickproof function.
- Watchdog timer, powerful reboot and self-recovery watchdog can connect with the external unlock button.
- Dual relay outputs.
- Unlock output delay time: 0~99s.
- IP rating: 65.
- Dimension: 120*76*22mm.
- Dual relay outputs for door opening, door status detecting, open door by button.
 The function of door status detecting is for ZONE 1 only.

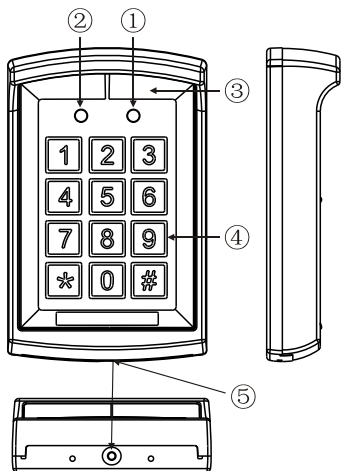

ZS30

| NO. | Description |
|-----|----------------|
| ① | Mode indicator |
| ② | Door indicator |
| ③ | Antenna |
| ④ | Matrix keypads |
| ⑤ | Case screw |

Working conditions:

temperature: -20C ~ +50C

RH: ≤95%

Current and voltage requirements:

DC input: --- +12V - +24V

AC input: ~ 12V - 24V

standby current: ≤80mA

working current: ≤110mA

Applicable card mode:

EM ID card(Default)

T5557/T5567 card(Setting required)

Effective distance: 5cm

Capacity:

ZONE 1: up to 1000 passwords & card holders

ZONE 2: up to 10 passwords OR card holders

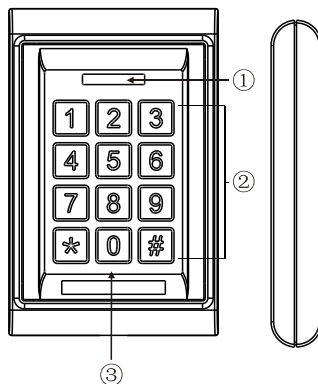

ZS50

| NO. | Description |
|-----|----------------|
| ① | Mode indicator |
| ② | Matrix keypads |
| ③ | Antenna |

Working conditions:

temperature: -20C ~ +50C

RH: ≤95%

Current and voltage requirements:

DC input: --- +12V - +24V

AC input: ~ 12V - 24V

standby current: ≤80mA

working current: ≤110mA

Applicable card mode:

EM ID card(Default)

T5557/T5567 card(Setting required)

Effective distance: 5cm

Capacity:

ZONE 1: up to 1000 passwords & card holders

ZONE 2: up to 10 passwords OR card holders

Specifications / Features

1. With internal EM reader.
2. Frequency: 125KHz.
3. Effective distance: 5cm.
4. ZONE 1: up to 1000 passwords & card holders.
ZONE 2: up to 10 passwords OR card holders..
5. Card access, code access and combined access.
6. Digital keypad operation.
7. Built-in pickproof function.
8. Watchdog timer, powerful reboot and self-recovery watchdog can connect with the external unlock button.
9. Dual relay outputs.
10. Unlock output delay time: 0~99s.
11. IP rating: 65.
12. Dimension: 120*76*28mm.
13. Dual relay outputs for door opening, door status detecting, open door by button.
The function of door status detecting is for ZONE 1 only.

Specifications / Features

1. With internal EM reader.
2. Frequency: 125KHz.
3. Effective distance: 5cm.
4. ZONE 1: up to 1000 passwords & card holders.
ZONE 2: up to 10 passwords OR card holders..
5. Card access, code access and combined access.
6. Digital keypad operation.
7. Built-in pickproof function.
8. Watchdog timer, powerful reboot and self-recovery watchdog can connect with the external unlock button.
9. Dual relay outputs.
10. Unlock output delay time: 0~99s.
11. IP rating: 65.
12. Dimension: 123*79*21mm.
13. Dual relay outputs for door opening, door status detecting, open door by button.
The function of door status detecting is for ZONE 1 only.

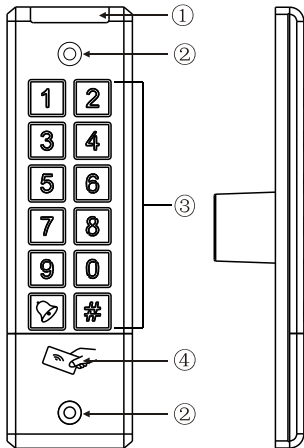

| NO. | Description |
|-----|----------------|
| ① | Mode indicator |
| ② | Case screw |
| ③ | Touch keypads |
| ④ | Antenna |

Working conditions:

temperature: -20C ~ +50C
RH: ≤95%

Current and voltage requirements:

DC input: --- +12V - +24V
AC input: ~ 12V - 24V
standby current: ≤80mA
working current: ≤110mA

Applicable card mode:

EM ID card(Default)
T5557/T5567 card(Setting required)

Effective distance: 5cm

Capacity:

ZONE 1: up to 1000 passwords & card holders
ZONE 2: up to 10 passwords OR card holders

ZS32

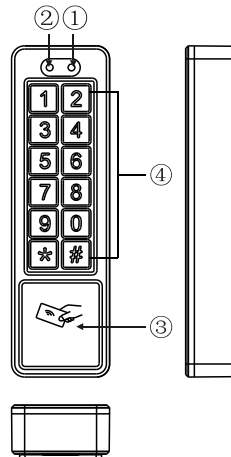

| NO. | Description |
|-----|----------------|
| ① | Mode indicator |
| ② | Door indicator |
| ③ | Antenna |
| ④ | Matrix keypads |

Working conditions:

temperature: -20C ~ +50C
RH: ≤95%

Current and voltage requirements:

DC input: --- +12V - +24V
AC input: ~ 12V - 24V
standby current: ≤80mA
working current: ≤110mA

Applicable card mode:

EM ID card(Default)
T5557/T5567 card(Setting required)

Effective distance: 5cm

Capacity:

ZONE 1: up to 1000 passwords & card holders
ZONE 2: up to 10 passwords OR card holders

ZS-52

Specifications / Features

1. With internal EM reader.
2. Frequency: 125KHz.
3. Effective distance: 5cm.
4. ZONE 1: up to 1000 passwords & card holders.
ZONE 2: up to 10 passwords OR card holders..
5. Card access, code access and combined access.
6. Digital keypad operation.
7. Built-in pickproof function.
8. Watchdog timer, powerful reboot and self-recovery watchdog can connect with the external unlock button.
9. Dual relay outputs.
10. Unlock output delay time: 0~99s.
11. IP rating: 65.
12. Dimension: 155*44*10mm.
13. Dual relay outputs for door opening, door status detecting, open door by button.
The function of door status detecting is for ZONE 1 only.

Specifications / Features

1. With internal EM reader.
2. Frequency: 125KHz.
3. Effective distance: 5cm.
4. ZONE 1: up to 1000 passwords & card holders.
ZONE 2: up to 10 passwords OR card holders..
5. Card access, code access and combined access.
6. Digital keypad operation.
7. Built-in pickproof function.
8. Watchdog timer, powerful reboot and self-recovery watchdog can connect with the external unlock button.
9. Dual relay outputs.
10. Unlock output delay time: 0~99s.
11. IP rating: 65.
12. Dimension: 152*45*25mm.
13. Dual relay outputs for door opening, door status detecting, open door by button.
The function of door status detecting is for ZONE 1 only.

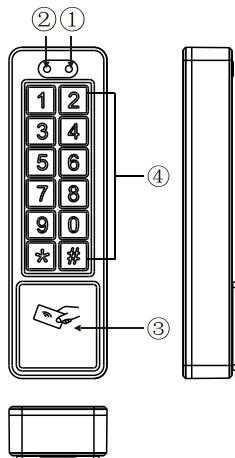

ZS-82

| NO. | Description |
|-----|----------------|
| ① | Mode indicator |
| ② | Door indicator |
| ③ | Antenna |
| ④ | Matrix keypads |

Working conditions:

temperature: -20C ~ +50C

RH: ≤95%

Current and voltage requirements:

DC input: --- +12V - +24V

AC input: ~ 12V - 24V

standby current: ≤80mA

working current: ≤110mA

Applicable card mode:

EM ID card(Default)

T5557/T5567 card(Setting required)

Effective distance: 5cm

Capacity:

ZONE 1: up to 1000 passwords & card holders

ZONE 2: up to 10 passwords OR card holders

Specifications / Features

1. With internal EM reader.
2. Frequency: 125KHZ.
3. Effective distance: 5cm.
4. ZONE 1: up to 1000 passwords & card holders.
ZONE 2: up to 10 passwords OR card holders..
5. Card access, code access and combined access.
6. Digital keypad operation.
7. Built-in pickproof function.
8. Watchdog timer, powerful reboot and self-recovery watchdog can connect with the external unlock button.
9. Dual relay outputs.
10. Unlock output delay time: 0~99s.
11. IP rating: 65.
12. Dimension: 165*45*23.5mm.
13. Dual relay outputs for door opening, door status detecting, open door by button.
The function of door status detecting is for ZONE 1 only.

Installation



NOTICE

Attention items of disassembly (ZS10/ZS30)

1. Please remove the cover carefully following the manual. Not permitted to remove with sudden force.
2. Before remove the cover, push up the front cover a few millimeters, then follow Picture 3, lift the lower cover for less than 20° and remove the front cover gently.

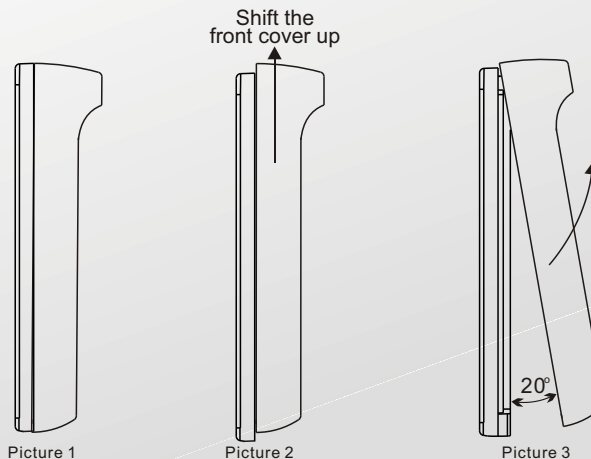

Installation

Applicable mode: ZS10//30/50/

Before installation, position the location where the controller unit is mounted. Please operate it according to the following steps:

1. Open the controller by loosening and removing the back case screw at the bottom with the spline tool.
2. Use the provided drilling template to accurately locate and drill the required holes. The four drilling holes are marked "B".
3. Use the screws provided to mount the back case on the wall. Be sure to draw the wiring through the large centre hole in back case, and keep level.
4. Connected accurately the system wiring following the label enclosed on the rear.
5. Put the unit back and screw it on by using the spline tool.

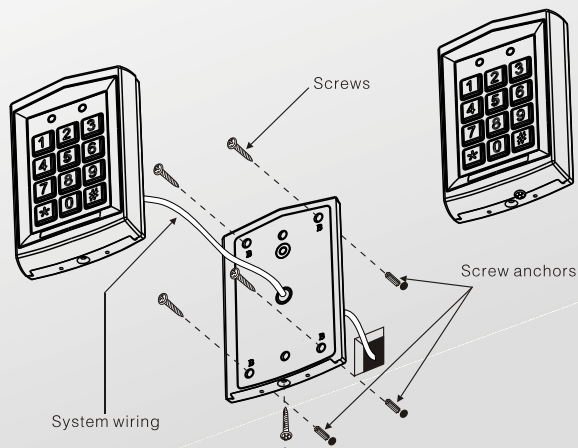

Installation

Applicable mode: ZS32

Find a suitable location to mount the keypad. Then please operate it according to the following steps.

1. Use the provided drilling template to accurately locate and drill the needed holes.
2. According to the wiring diagram to install.
3. Fix the unit with screws.

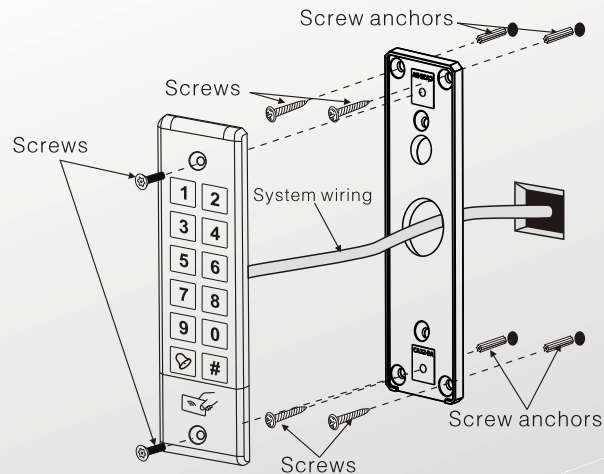

Installation

Applicable mode: ZS52/82

Before installation, position the location where the controller unit is mounted. Please operate it according to the following steps:

1. Open the controller by loosening and removing the back case screw at the bottom with the spline tool.
2. Use the provided drilling template to accurately locate and drill the required holes. The four drilling holes are marked "B".
3. Use the screws provided to mount the back case on the wall. Be sure to draw the wiring through the large centre hole in back case, and keep level.
4. Connected accurately the system wiring following the label enclosed on the rear.
5. Put the unit back and screw it on by using the spline tool.

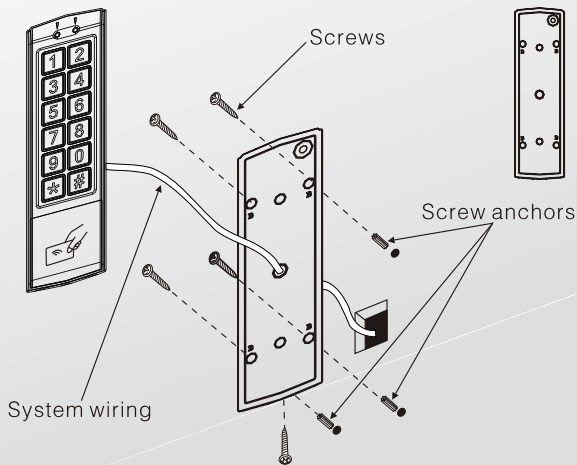

Operation

1. ZONE 1 and 2 relays can be programmed for opening the lock, up to 1000 user cards and correlative codes can be stored into ZONE 1, 10 user cards or codes can be stored into ZONE 2. In addition, ZONE 1 can be programmed for 3 modes to open the lock: card access (use card only), card and code access (use either card or code), and combined access (use card and code together). ZONE 2 could be programmed for door bell.
2. Default code is 1234.
3. Input the admin default code twice (1234+1234). But
 - a. If the admin default code you set is two digits, please input 12 12
 - b. If the admin default code you set is three digits, please input 123 123
 - c. If the admin default code you set is five digits, please input 12345 12345

The rest may be deduced by analogy..... The admin codes is max 6 digits. After you enter in the setting mode, the yellow LED will be on.



NOTICE



In mode: ZS32

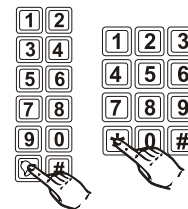



the button  replaces .







Access mode setting

In the setting mode:

Press the button  and , the mode indicator will flash yellow, follow the button  twice, the mode indicator will turn yellow, a long beep will be heard. It indicates that only the card access is available.

Press the button  and , the mode indicator will flash yellow, follow the button  and , the mode indicator will turn yellow, a long beep will be heard, it indicates that both the card and code access are available.

Press the button  and , the mode indicator will flash yellow, follow the button  and , the mode indicator will turn yellow and a long beep will be heard, it indicates that card and code access combined is available.

Press the button  to quit the setting mode.

Set the length of passwords

In the setting mode:

Press the button and yellow LED indicator will be flashing, then press the button and a sound "BI" as reminder, then input X(X=2,3,4,5,6):

2--Stands for the password/code digit length is 2(00-99)

3--Stands for the password/code digit length is 3(000-999)

The rest may be deduced by analogy, and the maximum is 6.

A sound "BI" as reminder, means digit length settings successfully. If the sound is "BI BI BI", means digit length is as same as the existence, and new setting is not permitted.

Press the button to quit setting mode.



NOTICE Once the digit length changed, all added cards and passwords will be cleared.

Add the user card and code(ZONE 1)

In the setting mode:

Enter one set number(3 digits) from 000 to 999 data storage units, yellow LED indicator will be flashing:

1. If red LED indicator is on, means there is data stored in this set of unit, press the button twice to clean up;
2. If green LED indicator is on, means this number data storage unit can be added card and passwords in.

Add card and passwords steps:

1. Enter in setting mode, and the yellow LED indicator will be flashing.
2. Input three-figure from 000 to 999 data storage units, and the green LED indicator lighting.
3. Swipe card, and a sound "BI" means added in. Then input the correlative passwords(correlative for the card just added in this data storage unit). The length of passwords should be the same as admin code. For example, the admin code is 12 (two is the length), herein should setting two digits passwords, you can set 00-99 as your passwords. If the admin code is 123 (three is the length), herein should setting three digits passwords, you can set 00-999 as your passwords. The rest may be deduced by analogy..... After the sound "BI", means card added in and passwords setting successfully.

Press the button to quit setting mode.

Delete the user card and code(ZONE 1)

In the setting mode:

Enter one set number(3 digits) from 000 to 999 data storage units, if red LED indicator is on, means there is data stored in this set of unit, press the button twice to delete the card and code.

Add the user card or code(ZONE 2)

In the setting mode:

Press the button and , the yellow LED indicator will be flashing, input two-figure from 00 to 09 data storage units, yellow LED indicator will be flashing:

1. But if red LED indicator light is on, it means there is data stored in this set of unit.
storage unit existed data, press the button twice to clean up;
2. If green LED indicator light is on, it means this number data storage unit can be added card or password in.

Add card or passwords steps:

Swipe card, and a sound "BI" means added in; OR in putt hec orrelative passwords (correlative for the card just added in this data storage unit) the length of passwords should be as same as admin code. For example, the admin code is 12 (two is the length), herein should setting two digits passwords, you can set 00-99 as your password. The admin code is 123(three is the length), herein should setting three digits passwords, you can set 000-999 as your passwords. The rest may be deduced by analogy..... After the sound "BI", means card added in or passwords setting successfully.
Press the button to quit the setting mode.

Delete the user card or code(ZONE 2)

In the setting mode:

Press the button and , the yellow LED indicator will be flashing, input two-figure from 00 to 09 data storage units, if red LED indicator light is on, it means there is data stored in this set of unit, press the button twice to delete the card or code.

Set the unlocking time for ZONE 1

In the setting mode:

Press the button **[*]** and **[1]**, the mode indicator will flash yellow, enter the number from 00 to 99, the mode indicator will turn yellow in the mean time a long beep will be heard, it indicates a success of delay time setting. 00-99 means the delay time, eg. 05 means the unlocking time is 5s delayed. If setting lock-time as 00 means: swipe card or input password once to open the door, swipe card or input password again to close the door.

Press the button **[#]** to quit the setting mode.

Set the unlocking time for ZONE 2

In the setting mode:

Press the button **[*]** and **[5]**, the mode indicator will flash yellow, enter the number from 00 to 99, the mode indicator will turn yellow in the mean time a long beep will be heard, it indicates a success of delay time setting. 00-99 means the delay time, eg. 05 means the unlocking time is 5s delayed.

If setting lock-time as 00 means: swipe card or input password once to open the door, swipe card or input password again to close the door.

Press the button **[#]** to quit the setting mode.

Clean all user cards and codes, restores to factory defaults

In the setting mode:

Press the button **[*]** and **[6]** (mode indicator will flash yellow), follow the button **[6]** twice, (a continuous beep will be heard and mode indicator will turn yellow), it indicates all user cards and codes have been cleaned out successfully.

Press the button **[*]** and **[8]** (mode indicator will flash yellow), follow the button **[9]** twice, (a continuous beep will be heard and mode indicator will turn yellow), it indicates it restores to factory defaults.

Press the button **[#]** to quit the setting mode and standby.

If enter wrong information, it will imply as BI.BI. sounds. The device would turn back without actions in 30 seconds automatically accompany with BI. BI. sounds. If it is not in the setting mode and press incomplete numbers, and if unlock door by card and password (combined) but only one action is done, then it will turn back in 5s automatically accompany with BI.BI. sounds.

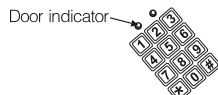

- A. When ZONE 1 relay activated, door indicator will turn green.
- B. When ZONE 2 relay activated, door indicator will turn red.

In case forget the admin code, press the button **[*]** and hold on, then power on (Notice: DH16A-20DT/DTQ DH16A-32DT/DTQ, power on first, then press the button **[#]** in 3s). A sound "BI" as reminder, means admin code default setting successfully.

- Digit length is 2--default admin code is 12,
- Digit length is 3--default admin code is 123,
- Digit length is 4--default admin code is 1234,
- Digit length is 5--default admin code is 12345,
- Digit length is 6--default admin code is 123456(Maximum is 6).

The pickproof alarm

The built-in buzzer will send a continuous beeping if the photoresistor sensor is directly exposed into the light. The buzzer will be off automatically in 60 seconds when the light is no longer detected, or by entering the admin code.

Modify administrator code

In the setting mode:

Press the button **[*]** and **[3]**, the yellow LED indicator will be flashing, then input a new administrator code twice (The length of the new admin code must be same as the old one) and a sound "BI" means modify successfully.

Press the button **[#]** to quit the setting mode.

Turn on/off the pickproof alarm

In the setting mode:

Press the button **[*]** and **[6]** (mode indicator will flash yellow), follow with the **[0]** and **[1]**, a long beep will be heard whilst the mode indicator will turn yellow, pickproof alarm is turned off.

Press the button **[*]** and **[6]** (mode indicator will flash yellow), follow with the **[0]** and **[2]**, a long beep will be heard whilst the mode indicator will turn yellow, pickproof alarm is turned on.

Press the button **[#]** to quit the setting mode.

Turn on/off the door bell

In the setting mode:

Press the button **[*]** and **[2]** (mode indicator will flash yellow), follow with the **[0]** and **[1]** , a long beep will be heard whilst the mode indicator will turn yellow, the function of door bell is turned off.

Press the button **[*]** and **[2]** (mode indicator will flash yellow), follow with the **[0]** and **[2]** , a long beep will be heard whilst the mode indicator will turn yellow, the function of door bell is turned on.

Press the button **[#]** to quit the setting mode.

NOTICE: The relay in ZONE 2 for door bell is available if the function of door bell is turned on but the function of door lock is inactive. Press the button **[*]** in standby mode, the relay contacts one time, the door bell ringing is triggered.

Add the master card(only for ZONE 1)

In the setting mode:

Press the button **[*]** and **[7]** , the mode indicator will flash green, it indicates there is no master card stored, if the indicator turns red, it indicates there is already data existed, press the button **[*]** twice to clean up the data, and then indicator will flash green, swipe the master card, a long beep will be heard, it indicates that adding successfully.

Press the button **[#]** to quit the setting mode.

Using the master card enter the setting mode

Swipe the master card, the indicator will flash yellow whilst a long "BI" will be heard, enter the setting mode. Swipe the master card again, the indicator will turn green whilst three times rapid beep sound will be heard-exit the setting mode.

The access control will be locked for 60s if the mistaken code continuously input or swipe the invalid card for 5 times(both the keypad operating and the card swiping is not available during the 60 seconds).

Detect the door status: when someone opens the door and comes in, the door is closed, the system will automatically detect the door status and lock the door even though it is still in delay period(For ZONE 1 only).



NOTICE

The user code must be different from the administration code.
The code of ZONE 1 must be different from that of ZONE 2.

Group cards added in ZONE 1

In the setting mode:

Press the button **[*]** and **[9]** , the yellow LED indicator will be flashing, then press the button **[0]** and **[1]** , a sound "BI" as reminder. Then input three-figure 000 to 999 data storage units as start added unit, and input 3 digits number indicates the cards quantity you want to add in. For example:

1. Input 005 060--means the cards added in storage units starting from 005, and the quantity of the whole cards added in are 60.
2. Input 060 150--means the cards added in storage units starting from 060, and the quantity of the whole cards added in are 150.

After adding cards, a sound "BI" as reminder. Swipe the first added card or input the first added card serial number(8 digits), a sound "BI" as reminder, means added in successfully.

Press the button **[#]** to quit setting mode.

Modify the user code of ZONE 1

In the setting mode:

Press the button **[*]** and **[9]** , the yellow LED indicator will be flashing, then press the button **[0]** and **[2]** , a sound "BI" as reminder. Then input three-figure 000 to 999 data storage units and input correlative passwords (The length of relative passwords should as same as admin code).

Press the button **[#]** to quit setting mode.

Setting access control ID(for networked modes only)

In the setting mode:

Press the button **[*]** and **[9]** , the yellow LED indicator will be flashing, then press the button **[0]** and **[3]** , a sound "BI" as reminder. Then input 6 digits ID number, and a sound "BI" as reminder, means ID setting successfully.

Press the button **[#]** to quit setting mode.

WARRANTY CARD

Product name: ACCESS CONTROL

Model: _____

.....
Date of sale

Seller's seal and signature

1. Wena Company shall grant a warranty for the purchase of your product for a period of 24 months from the date of its purchase as shown on the present Warranty Card and the purchase document.
2. Product defects found during the warranty period shall be repaired free of charge within 21 working days from the date of acceptance of your product at the service centre.
3. The user has the right to replace the product with a new one if;
 - > four major repairs have been conducted during the warranty period and the product is still defective;
 - > when it is established that an unrecoverable defect has occurred. When replacing the product with a new one, the equivalent of items (including packaging) which are missing or damaged by the user as well as the cost of their replacement shall be deducted.
4. The user shall deliver the defective product at its own expense to the service centre.
5. The warranty shall not cover the deterioration of the product quality caused by standard wear and tear and in the following cases:
 - > the product has been used improperly or inconsistently with the product operating instructions;
 - > the product has been used or left in improper conditions (excessive humidity, too high or low temperature, sunlight, etc.), maintenance and operational condition which are different from the ones specified in the product operating instructions;
 - > mechanical, chemical and thermal damage;
 - > damage caused by external forces, e.g. overvoltage in the electrical network, atmospheric discharges, flood, fire;
 - > damage resulting from improper installation, improper storage of the device or repairs conducted by any unauthorised persons;
 - > damage due to incorrect voltage connection.
6. The guarantee shall cease to be valid as a result:
 - > breakage or damage of warranty seals;
 - > connection of additional equipment, other equipment than the one recommended by the product manufacturer;
 - > modifications and structural changes to the product and repairs conducted beyond the Wena service centre;
 - > the Guarantee Card or serial number have been changed, blurred or obliterated.
7. The Guarantee Card shall be valid only with the entered date of sale confirmed by the seller's seal and signature.
8. The condition to perform repair works is to deliver the Product with the Warranty Card and the proof of purchase.
9. Service Centre:

Firma Handlowa Wena
Al. Jerozolimskie 311 ,
05 - 816 Reguly / near Warsaw
Poland
tel. +48 228 370 286; +48 228 174 003
e-mail: biuro@vidos.pl
www.vidos.pl