

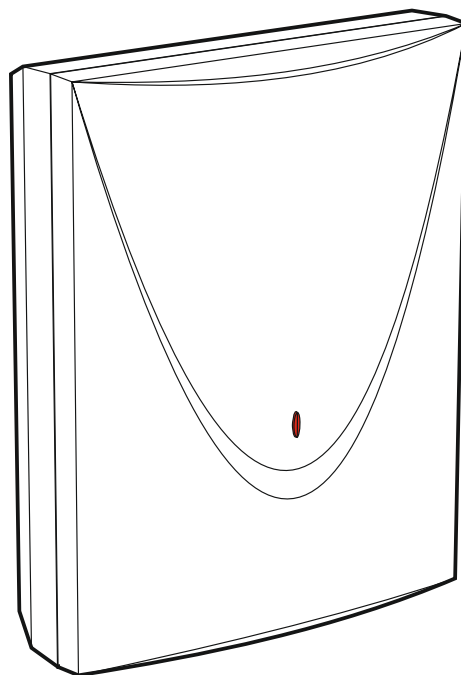

GSM-X LTE

Communication module



Firmware version 1.03

gsm-x_lte_en 09/20

SATEL sp. z o.o. • ul. Budowlanych 66 • 80-298 Gdańsk • POLAND
tel. +48 58 320 94 00
www.satel.eu

IMPORTANT

The module should be installed by qualified personnel.

Prior to installation, please read carefully this manual in order to avoid mistakes that can lead to malfunction or even damage to the equipment.

Disconnect power before making any electrical connections.

Changes, modifications or repairs not authorized by the manufacturer shall void your rights under the warranty.

Connect the module to the **analog telephone line**. Connecting it to a digital network (e.g. ISDN) may cause damage to devices connected to the module.

The name plate of the device is located on the enclosure base.

FreeRTOS is used in this device (www.freertos.org).

SATEL's goal is to continually upgrade the quality of its products, which may result in some changes of their technical specifications and firmware. The current information on the introduced modifications is available on our website.

Please visit us:
<http://www.satel.eu>

Hereby, SATEL sp. z o.o. declares that the radio equipment type GSM-X LTE is in compliance with Directive 2014/53/EU. The full text of the EU declaration of conformity is available at the following internet address: www.satel.eu/ce

The following symbols may be used in this manual:



- note,



- caution.

Changes made to the firmware version 1.03

Additional modules	GSM-X-PSTN telephone module support.
Reporting	AUDIO reporting via the PSTN network (optionally, if GSM-X-PSTN is installed).

CONTENTS

1. Introduction.....	4
2. Features	4
3. Typical module applications.....	6
3.1 Backup communication path.....	6
3.2 Supervision / control of devices	7
3.3 Simulation of monitoring station.....	9
3.4 Work in conjunction with INTEGRA / INTEGRA Plus control panels	9
3.5 Work in conjunction with STAM-2 monitoring station	11
3.6 Work in conjunction with PBX stations.....	11
4. Description of the module	12
4.1 Electronics board.....	12
4.1.1 LED indicator.....	13
5. Installation	13
5.1 Preparing the cabling.....	14
5.2 Installation of enclosure	14
5.2.1 Elements inside the enclosure	15
5.3 Installation of antenna.....	15
5.4 Connecting the analog telephone line.....	15
5.5 Connecting the devices to the inputs and outputs.....	16
5.6 Connecting the RS-232 port	17
5.7 Connecting the power supply and starting the module.....	17
5.8 Connecting the computer to the module	18
5.9 Installing the SIM cards	18
6. GSM-X-ETH Ethernet module	18
6.1 Electronic boards.....	19
6.2 GSM-X-ETH module installation	19
7. GSM-X-PSTN telephone module.....	20
7.1 Electronics board.....	20
7.2 GSM-X-PSTN module installation.....	21
8. Configuring	22
8.1 Description of the GX Soft program	22
8.1.1 Menu bar in the GX Soft program	23
8.1.2 Side menu	24
8.1.3 Additional menu.....	25
8.2 Establishing connection between the program and the module	27
8.2.1 Local connection	27
8.2.2 Remote connection: SATEL server.....	28
8.2.3 Remote connection: Module>>GX Soft.....	28
8.3 Project	29
8.4 Data.....	30
8.5 Hardware.....	30
8.5.1 Mainboard	30
8.5.2 GSM	32
8.5.3 GSM-X-ETH/PSTN.....	35
8.6 Inputs	35
8.6.1 State	35
8.6.2 Settings	36
8.6.3 Blocking.....	36
8.7 Outputs.....	37
8.7.1 Control.....	37
8.7.2 Settings	37
8.7.3 Triggering	38
8.8 Communication.....	38
8.8.1 SATEL server	38
8.8.2 Direct connection to GX Soft.....	39
8.9 GSM gateway.....	40
8.9.1 PAGER to SMS conversion	42

8.9.2	PSTN to GSM prefix.....	43
8.9.3	Telephone numbers	43
8.10	Station simulation.....	43
8.11	Reporting	45
8.12	Messaging.....	49
8.13	Event converter	52
8.14	SMS/DTMF control.....	53
8.15	CLIP control	55
8.16	Data forwarding.....	57
8.17	Remote update	58
8.18	Users	60
8.19	Events.....	60
9.	GX Control application.....	61
10.	Control by using a telephone.....	63
10.1	Control from the telephone connected to output telephone line	64
10.2	Control from other telephones	64
10.2.1	From the keypad	64
10.2.2	Using SMS	64
10.2.3	Using CLIP	65
11.	Reporting events when the module is used with INTEGRA / INTEGRA Plus.....	66
12.	Converting the PAGER type messages into SMS messages.....	66
12.1	Working in conjunction with the DT-1 dialer.....	66
13.	Sending SMS messages from the telephone connected to telephone line output.....	66
14.	The rules for converting the numbers	68
15.	Module firmware update	68
15.1	Local update	68
15.2	Remote update	68
15.2.1	Initiating the update by using SMS message.....	68
16.	Restoring the factory settings	69
17.	Specifications	69
18.	Manual update history	70

1. Introduction

This manual describes the GSM-X LTE module and how it should be installed as well as configured using the GX Soft program. Described herein are also the optional components of the GSM-X LTE module: the GSM-X-ETH Ethernet module and the GSM-X-PSTN telephone module.

2. Features

Communication

- Built-in telephone designed for use in the 2G, 3G and 4G cellular networks.
- Dual SIM support (nano-SIM).
- Possibility to remotely check the account balance and validity of the SIM card installed in the module.
- Possibility to define the MCC / MNC code of the operator of network into which the module is to log in.
- Possibility to expand GSM-X LTE with the GSM-X-ETH module to add Ethernet link.
- Possibility to expand GSM-X LTE with the GSM-X-PSTN module to add additional transmission path for reporting purposes (AUDIO reporting via analog telephone line).

GSM gateway

- Simulation of analog telephone line by using cellular connection:
 - Tone dialing (DTMF).
 - Information on the caller number (CLIP FSK or DTMF).
 - Changing voltage polarity on the telephone line output when making phone connections (individual connection billing option).
- Possibility to generate routing signal.
- Possibility to work as a backup communication path for analog telephone line.
- Filtering capability for connections made via module cellular phone.
- Possibility to send SMS messages from telephone connected to the telephone line output.

Reporting

- Reporting events to two monitoring stations.
- Several communication formats:
 - SIA,
 - Contact ID (CID),
 - Ademco Express,
 - Sil. Knight / Ademco slow,
 - Radionics 1400Hz,
 - Radionics 1400 with parity.
- Multiple transmission paths:
 - GPRS / LTE,
 - GSM voice channel,
 - SMS messages,
 - Ethernet network (using GSM-X-ETH module).

- PSTN telephone network (using GSM-X-PSTN module).
- Defining priority for different paths of event reporting.
- Dual Path Reporting compliant with EN 50136 (requires GSM-X-ETH or GSM-X-PSTN module to be connected).
- Converting and retransmitting codes of events received from other devices (simulation of telephone monitoring station).

Messaging

- Notification of events related to the module and received from other devices.
- 8 telephone numbers to be notified.
- Notification by using:
 - voice messages,
 - SMS messages,
 - push messages (provided that GX Control application is installed on the user phone),
 - CLIP (toll-free).
- Programming voice messages from the GX Soft program.
- Capability of converting the PAGER type text messages into SMS messages.

Event log

- Capability of storing up to 500 events generated by the module or received from the control panel.

Inputs

- 8 programmable inputs (NO, NC).
- Supervising the state of external devices.
- Input blocking capability.

Outputs

- 4 programmable OC type outputs.
- Controlling external devices or signaling troubles.

Control

- Control of outputs or blocking of the module inputs by means of:
 - inputs,
 - telephone keypad (DTMF),
 - SMS messages,
 - GX Soft program,
 - GX Control application,
 - CLIP (only outputs control).
- Capability of determining the telephone numbers authorized for DTMF, SMS or CLIP control.

Work in conjunction with INTEGRA / INTEGRA Plus control panels

- Cellular network as the primary or backup communication path.
- Transmitting event codes to the monitoring station via cellular network or Ethernet / PSTN (optionally, after installation of the GSM-X-ETH / GSM-X-PSTN module).
- Messaging via cellular network.

- Remote programming of the control panels from a computer with DLOADX program installed (data transfer via cellular network).
- Remote administration of the alarm system by using a computer with GUARDX program installed (data transfer via cellular network).

Work in conjunction with STAM-2 monitoring station

- SMS or CLIP receiving capability for monitoring station.
- SMS sending capability for monitoring station.

Operation from mobile devices

- Free GX Control application for remote operation of the module.
- Functions available from the application:
 - checking the state of inputs and outputs,
 - blocking / unblocking inputs,
 - output control,
 - viewing troubles,
 - viewing event log.
- Simple and easy establishing remote communication between GX Control application and the module thanks to SATEL's connection setup service.

Configuring

- Free GX Soft program for local (USB port) and remote (data transfer via cellular network or Ethernet) configuring of the module.
- Simple and easy establishing remote communication between GX Soft program and the module thanks to SATEL's connection setup service.
- Possibility to configure the module settings by using SMS messages.

Firmware update

- Local firmware update by using a computer connected to USB MINI-B port.
- Remote update of the module firmware by using the “UpServ” server via cellular network or Ethernet (the latter optionally, if GSM-X-ETH module is installed).

LEDs

- LEDs indicating the module status.

Power supply

- Powering with 12 VDC ($\pm 15\%$).
- Connector for SATEL's dedicated power supply unit.

3. Typical module applications

The extended functionality of GSM-X LTE module enables it to be used for a variety of applications. This section presents typical examples of its application. Some of them are capable of being combined with one other.

3.1 Backup communication path

When connected to the telephone line output (T-1 and R-1 terminals), the devices are capable of making telephone calls via analog telephone line or cellular network. You can

select which communication path will be the primary one. If the primary communication path is malfunctioning, the module can automatically switch over to the backup one.

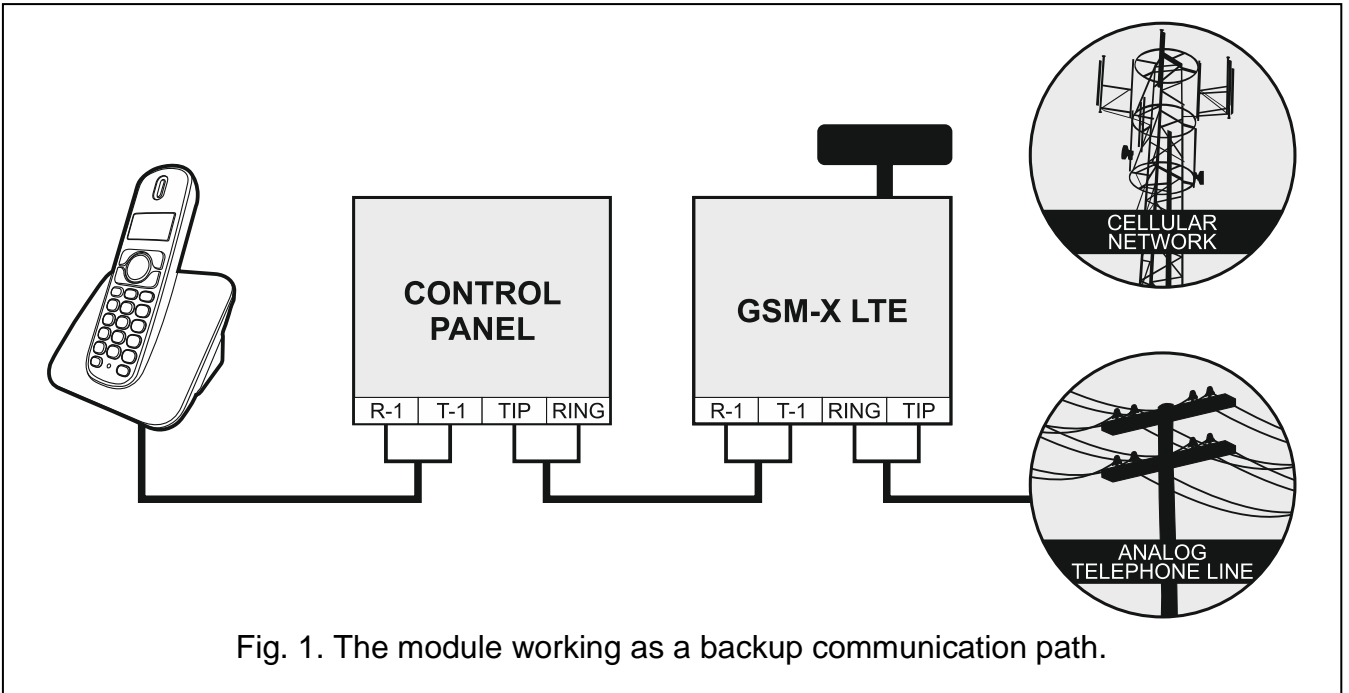

Fig. 1. The module working as a backup communication path.

3.2 Supervision / control of devices

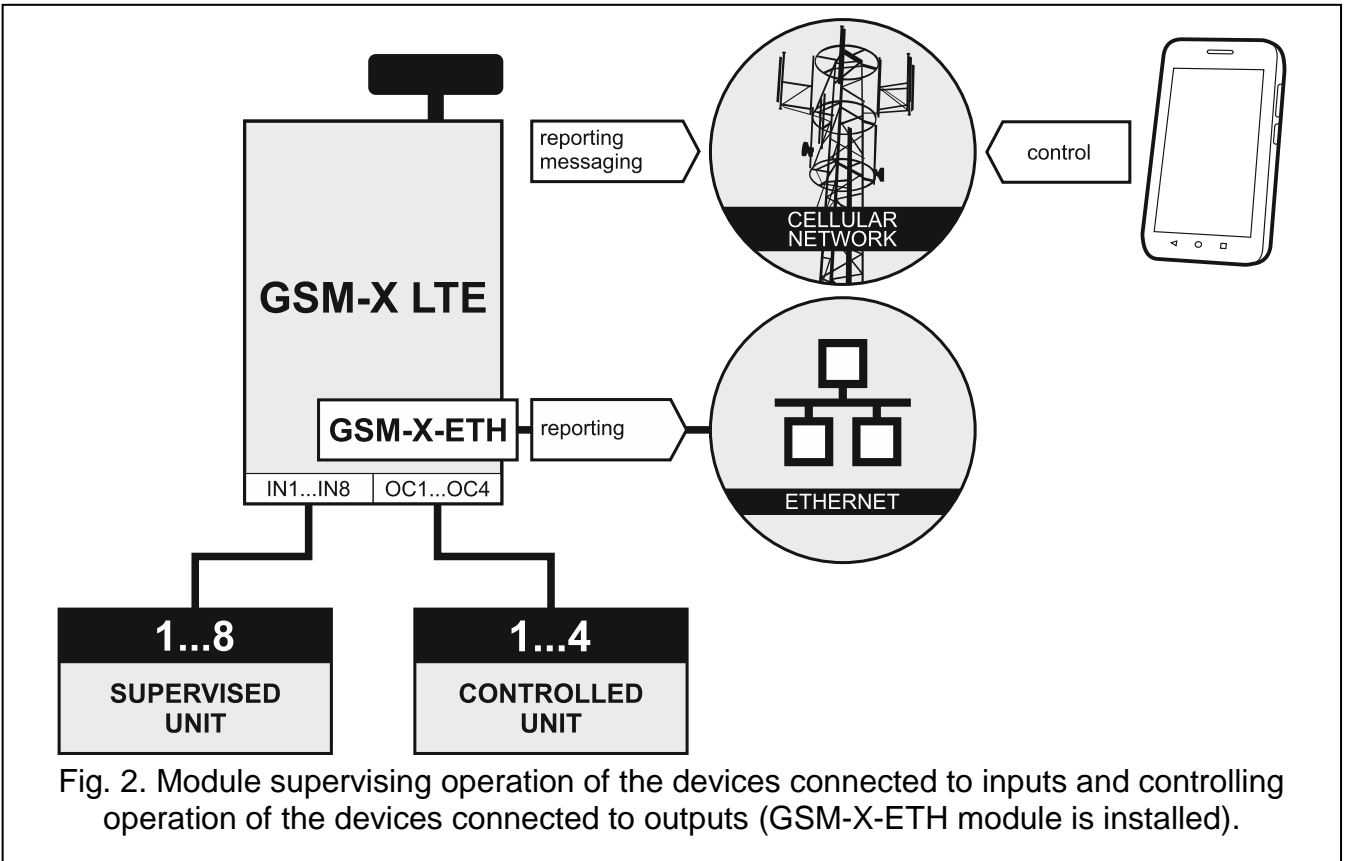

Fig. 2. Module supervising operation of the devices connected to inputs and controlling operation of the devices connected to outputs (GSM-X-ETH module is installed).

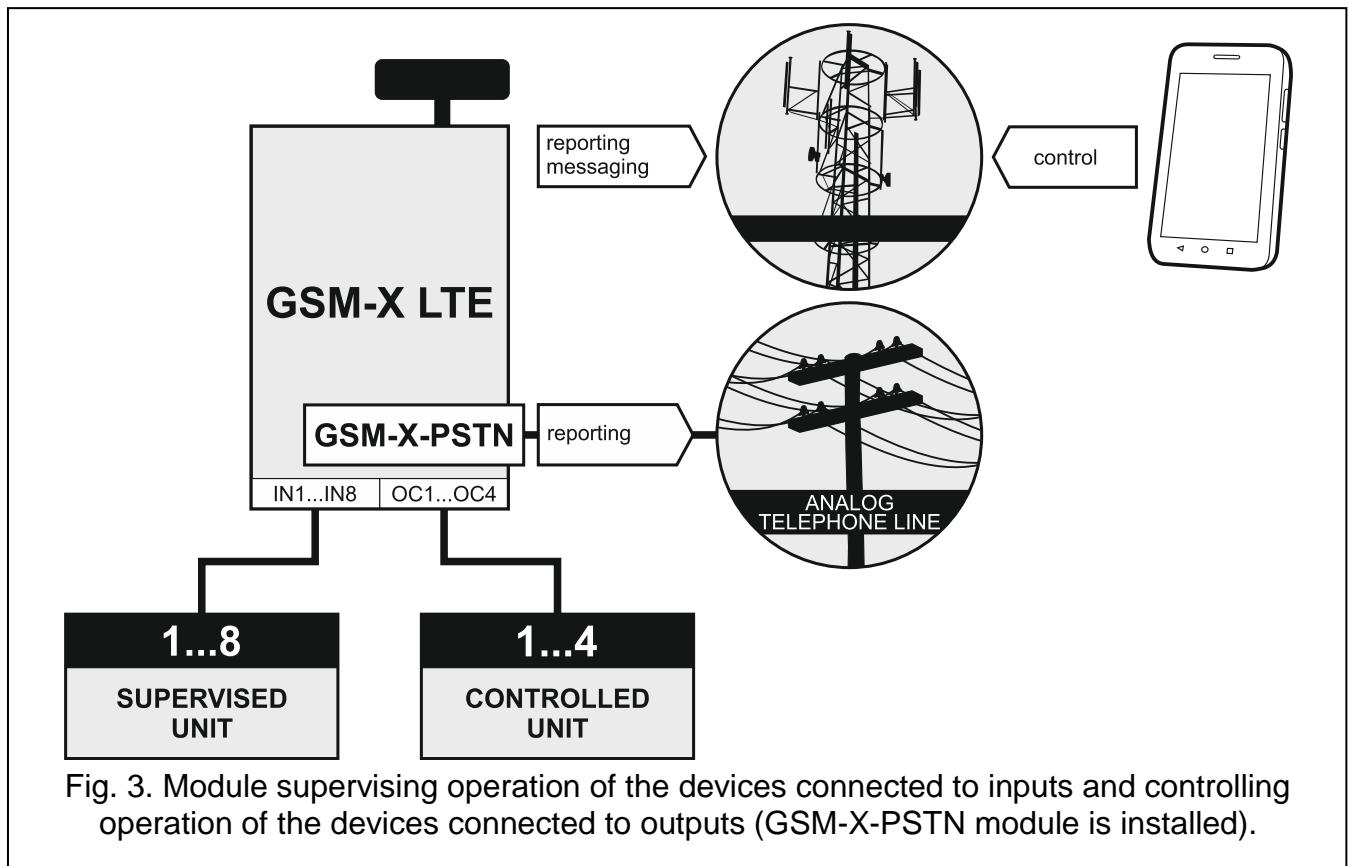

Fig. 3. Module supervising operation of the devices connected to inputs and controlling operation of the devices connected to outputs (GSM-X-PSTN module is installed).

The change of status of the input to which the supervised device is connected may result in:

- sending event code to the monitoring station (reporting GPRS/LTE, SMS or optionally via Ethernet network [if GSM-X-ETH module is installed – Fig. 2] or PSTN network [if GSM-X-PSTN module is installed – Fig. 3]),
- notification (messaging) about the event by means of voice message, SMS, push or CLIP.

The inputs can be blocked locally (by means of one of the module inputs, the keypad of telephone connected to the telephone line output or the GX Soft program) or remotely (by means of SMS messages, telephone keypad (DTMF), the GX Soft program or the GX Control application).

The devices connected to the module outputs can be controlled locally (by means of module inputs, the keypad of telephone connected to the telephone line output or the GX Soft program) or remotely (by means of SMS messages, telephone keypad (DTMF), CLIP, the GX Soft program or the GX Control application).

3.3 Simulation of monitoring station

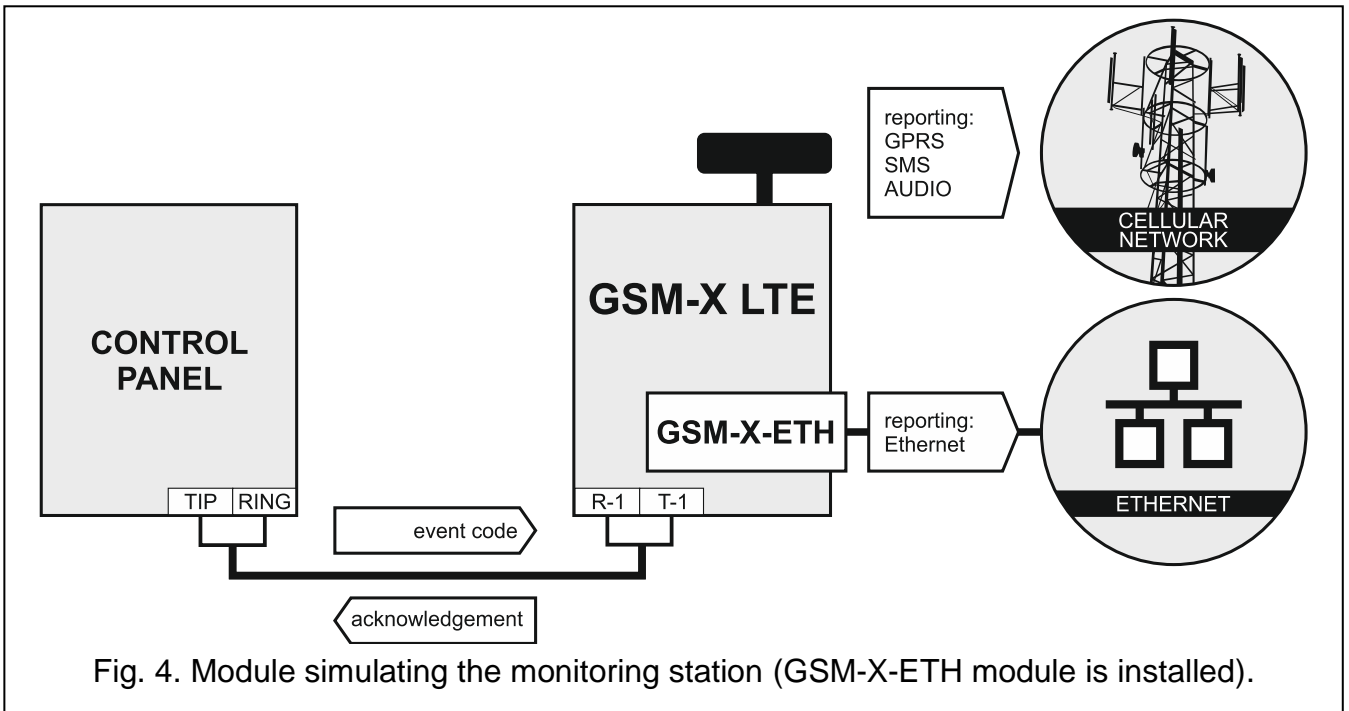

Fig. 4. Module simulating the monitoring station (GSM-X-ETH module is installed).

The module can forward the event codes received from the control panel to the monitoring station by means of cellular or, optionally, Ethernet network (if GSM-X-ETH module is installed – Fig. 4) / PSTN network (if GSM-X-PSTN module is installed – Fig. 5). Which reporting path will be used to send the event code depends on the module configuration.

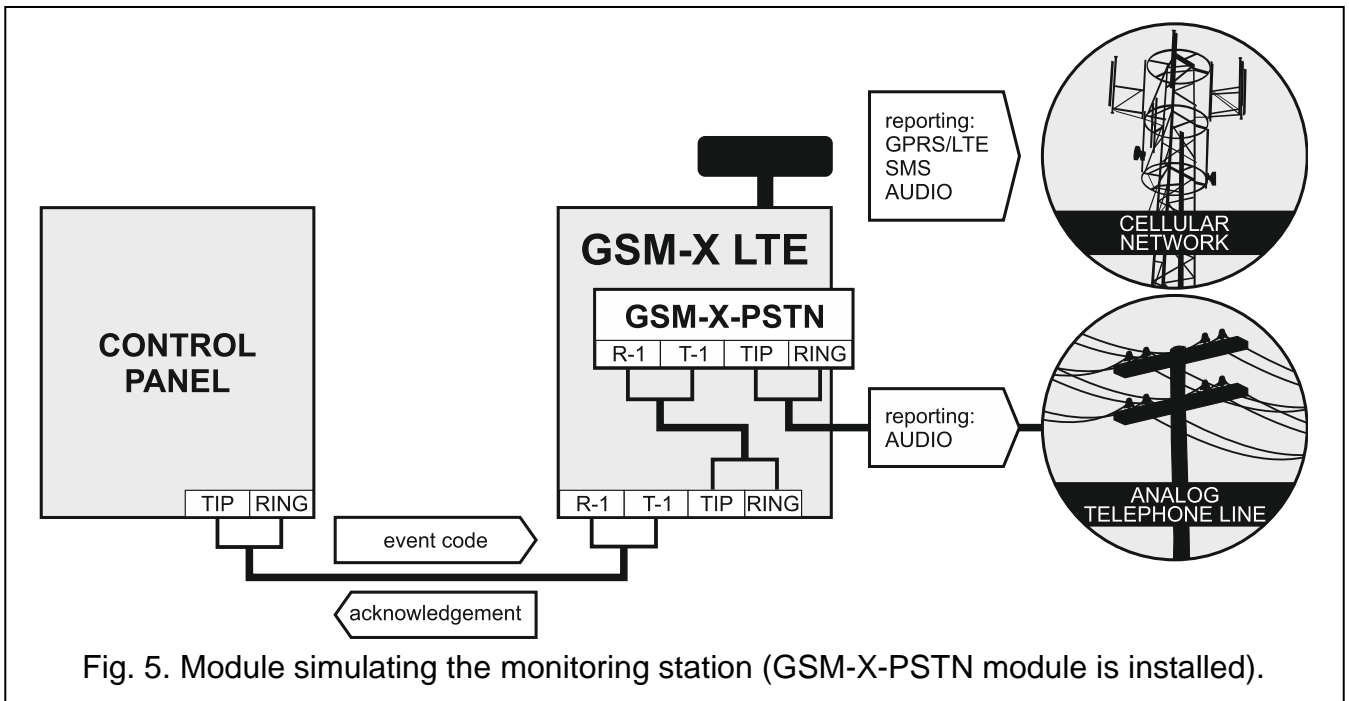

Fig. 5. Module simulating the monitoring station (GSM-X-PSTN module is installed).

3.4 Work in conjunction with INTEGRA / INTEGRA Plus control panels

When connected to the INTEGRA / INTEGRA Plus control panel, the module offers the following benefits:

- cellular network as the primary or backup communication path,

- transmission of event codes to the monitoring station via cellular or, optionally, Ethernet network (if GSM-X-ETH module is installed – Fig. 6) / PSTN network (if GSM-X-PSTN module is installed – Fig. 7),
- messaging via cellular network, including SMS messaging (for the INTEGRA Plus control panels, an additional feature is available: messaging by means of SMS messages, whose content corresponds to the description in event log and thus the installer does not need to define it),
- remote programming of the control panel from a computer with DLOADX program installed (data transfer via cellular network),
- remote management of the alarm system from a computer with GUARDX program installed (data transfer via cellular network).



If communication with the GSM-X LTE module is to be effected through the RS-232 port, the local programming function in the INTEGRA / INTEGRA Plus control panel must be disabled.

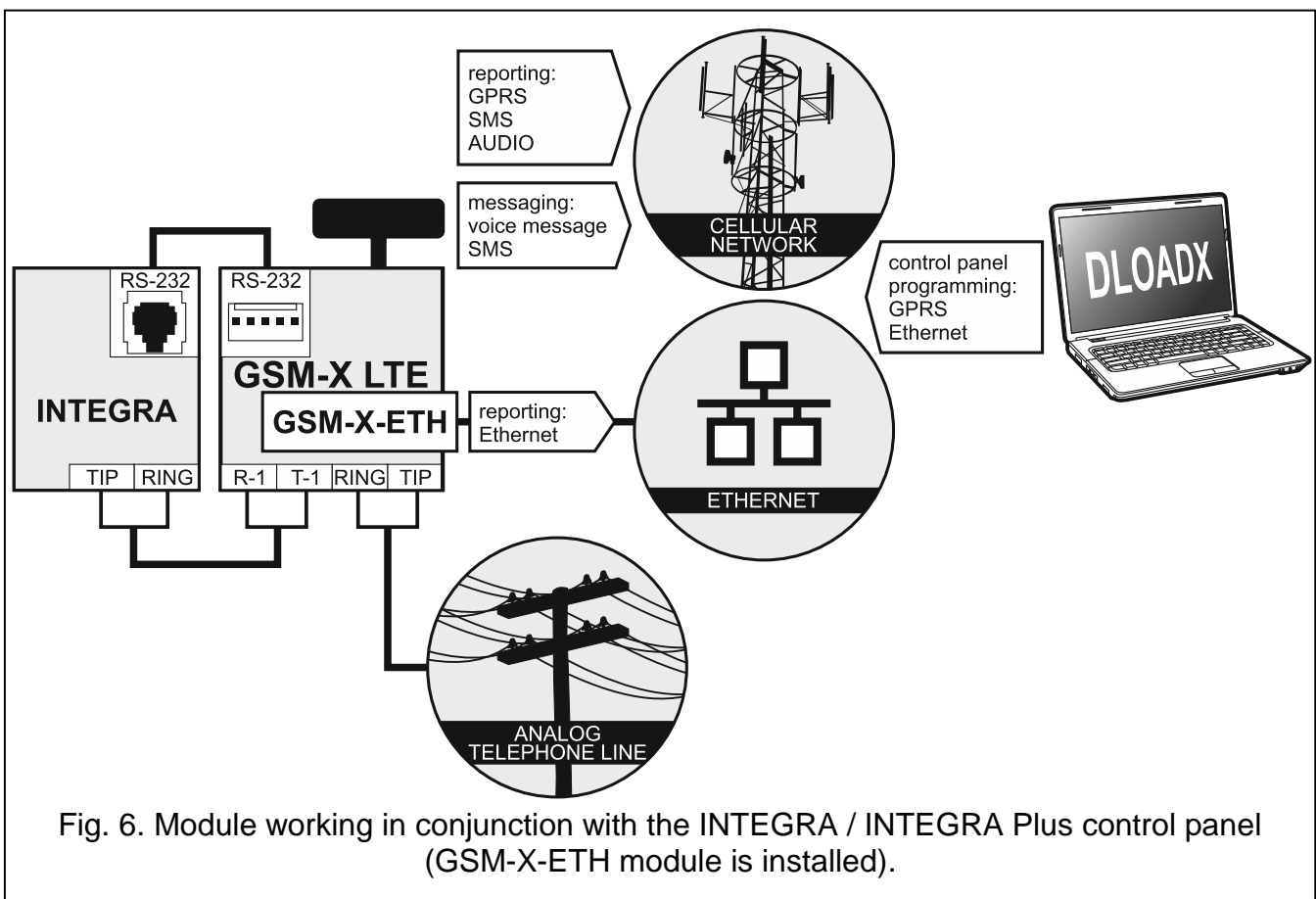

Fig. 6. Module working in conjunction with the INTEGRA / INTEGRA Plus control panel (GSM-X-ETH module is installed).

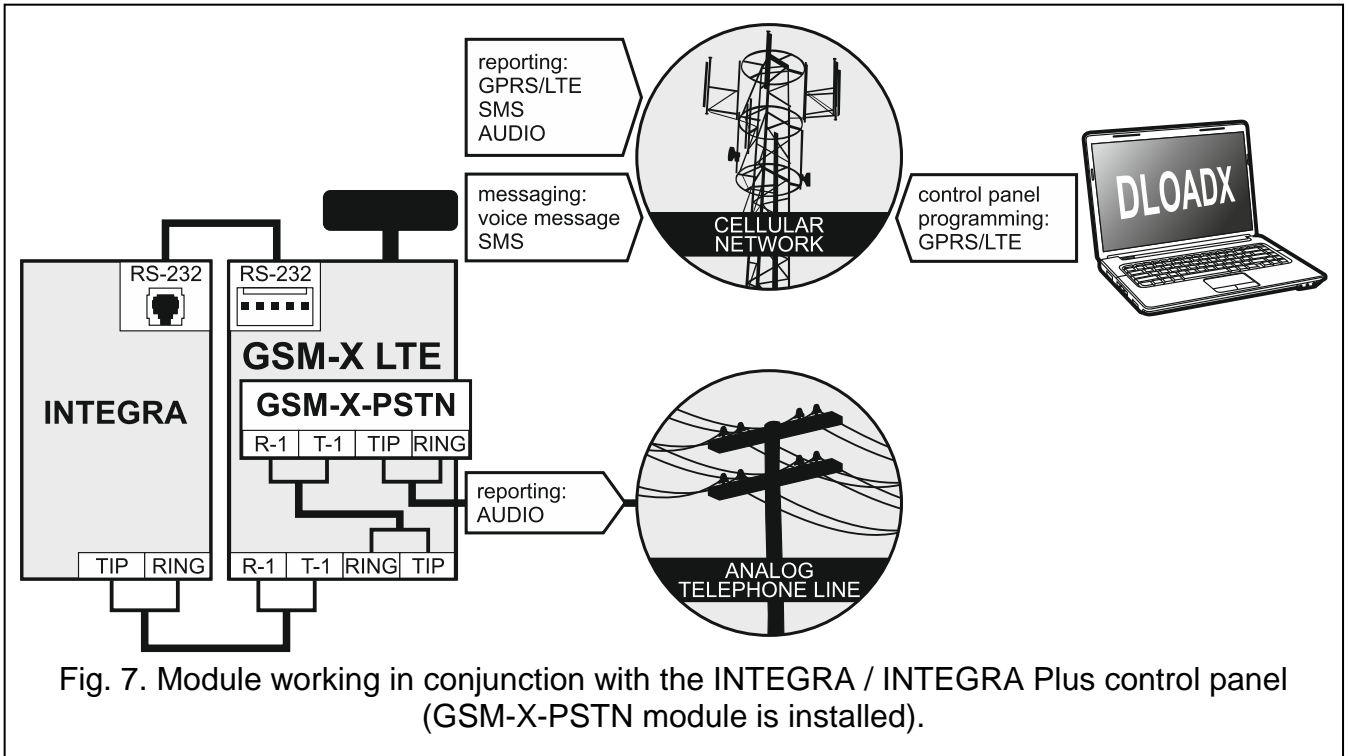

Fig. 7. Module working in conjunction with the INTEGRA / INTEGRA Plus control panel (GSM-X-PSTN module is installed).

3.5 Work in conjunction with STAM-2 monitoring station

When connected to the STAM-2 monitoring station, the module makes it possible to receive event codes sent in the form of SMS or CLIP. The module also enables the monitoring station to send SMS messages.

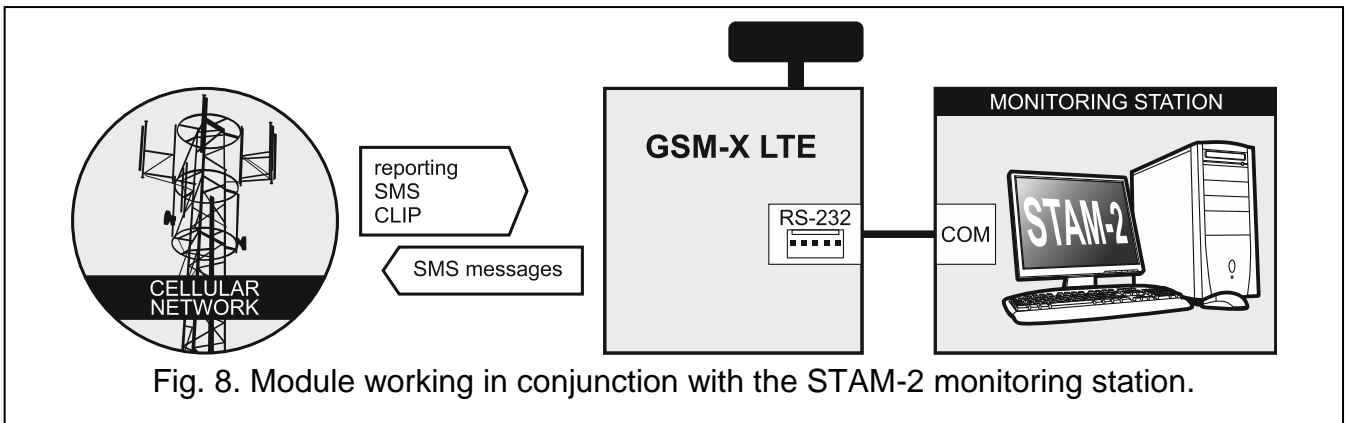

Fig. 8. Module working in conjunction with the STAM-2 monitoring station.

3.6 Work in conjunction with PBX stations

The module can work in conjunction with the Private Branch Exchanges (PBX) as an additional external telephone line. It can be used to make outgoing calls to the mobile phone numbers and thus decrease the costs incurred.

4. Description of the module

4.1 Electronics board

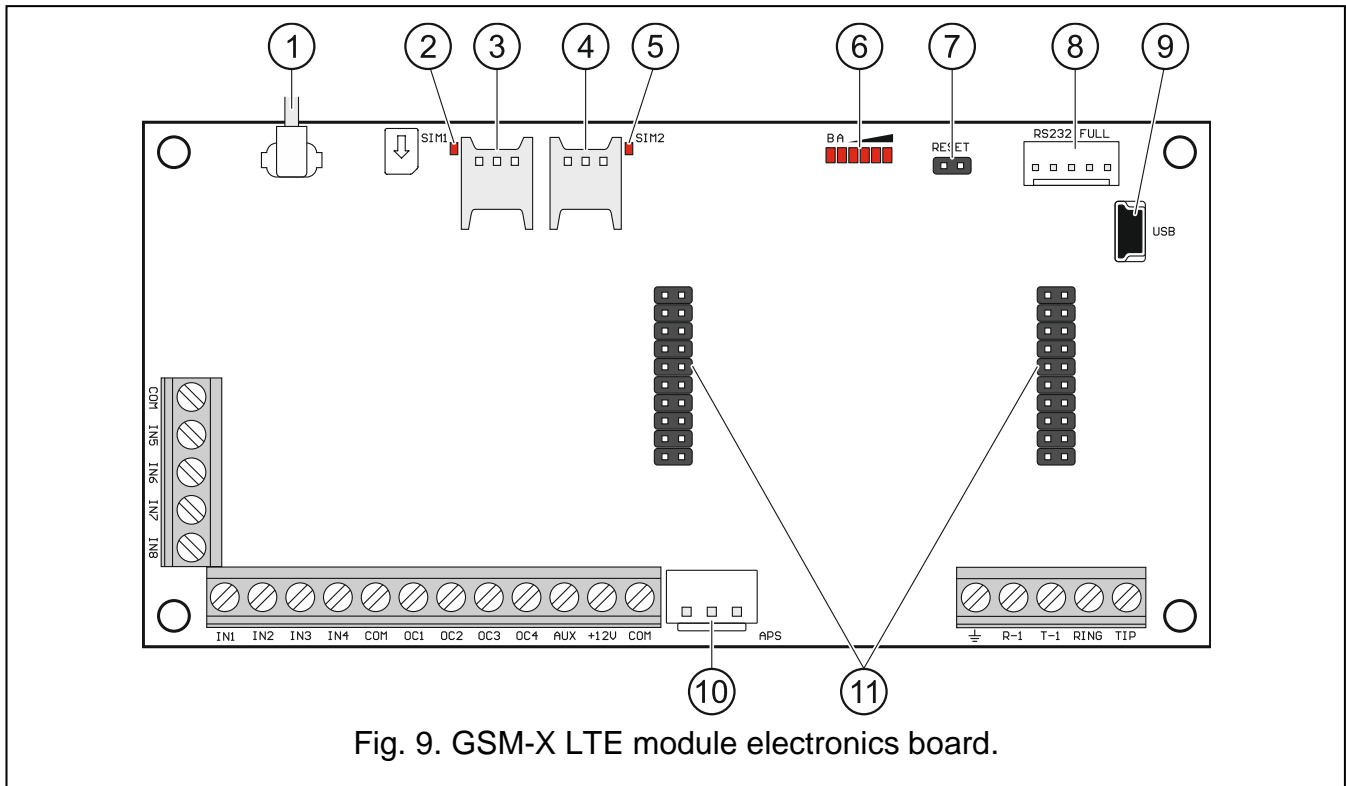

Fig. 9. GSM-X LTE module electronics board.

- ① antenna cable (the antenna is delivered with the module).
- ② SIM1 LED. The LED is on, when the card installed in the SIM 1 slot is active.
- ③ slot in which the first SIM card is to be installed.
- ④ slot in which the second SIM card is to be installed.
- i** *Inserting the SIM card into its slot before programming the card PIN code in the module is not recommended (if the card requires entering the PIN code).*
- ⑤ SIM2 LED. The LED is on, when the card installed in the SIM 2 slot is active.
- ⑥ LEDs indicating the module status (see “LED indicator”).
- ⑦ RESET pins for emergency update of the module firmware. Shorting the pins enters the module starter mode in which the module is waiting for the firmware update (see “Module firmware update” p. 68).
- ⑧ RS-232 port.
- ⑨ USB MINI-B socket.
- ⑩ APS connector for a SATEL power supply unit (e.g. APS-412).
- ⑪ connectors for the GSM-X-ETH module (see “GSM-X-ETH module installation” p. 19) or the GSM-X-PSTN module (see “GSM-X-PSTN module installation” p. 21).

Description of terminals

IN1...IN8 – inputs.

COM – common ground.

OC1...OC4 – OC type outputs (shorted to common ground when in active state).

- AUX** – +12 VDC power output.
- +12V** – power input (12 VDC \pm 15%).
- ⏏ – protective terminal of telephone communicator (to be connected only to the PE protective earth circuit of 230 VAC mains).
- R-1, T-1** – analog telephone line output (for connecting a telephone or a device fitted with telephone communicator, e.g. control panel).



When making a telephone call, the module changes the DC voltage polarity on telephone line output (T-1 and R-1 terminals), thus enabling individual charging of the phone calls.

- RING, TIP** – analog telephone line input (for connecting the incoming telephone line [from telephone provider] or the GSM-X-PSTN module).

4.1.1 LED indicator

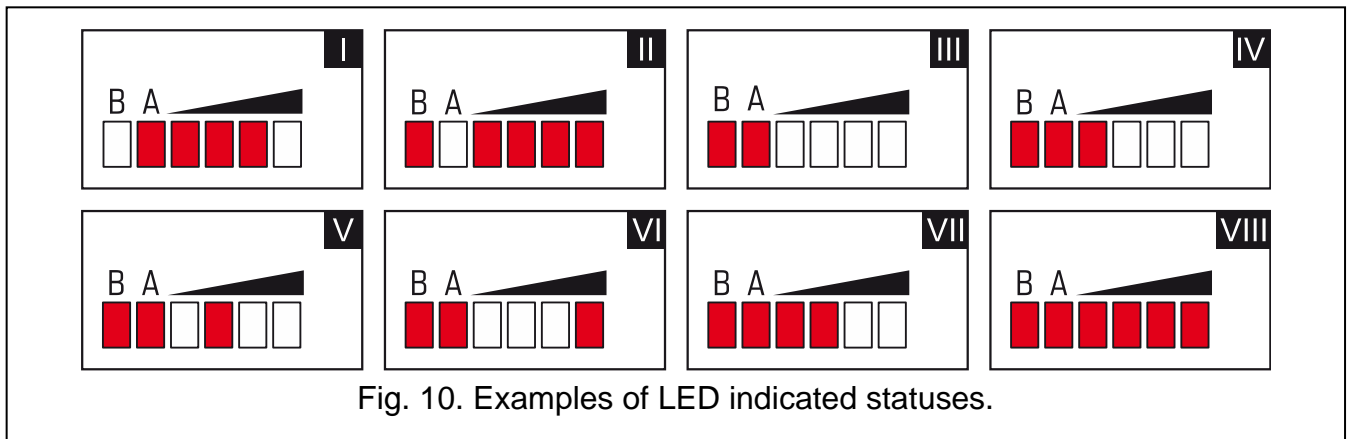

Fig. 10. Examples of LED indicated statuses.

- I** (LED A is flashing, the other LEDs are ON) – data transmission is going on; signal level: 3.
- II** (LED B is flashing, the other LEDs are ON) – SMS message is being sent, module is calling (AUDIO connection or CLIP message); signal level: 4.
- III** (LEDs are flashing) – logging into cellular network.
- IV** (LEDs are flashing) – logging into cellular network has failed; missing SIM card.
- V** (LEDs are flashing) – logging into cellular network has failed; incorrect PIN code.
- VI** (LEDs are flashing) – logging into cellular network has failed; SIM card has been blocked after three attempts to use an invalid PIN code (PUK code must be used to unblock the SIM card).
- VII** (LEDs are flashing) – cellular phone is disabled (see “SIM 1 / SIM 2” option p. 32).
- VIII** (LEDs are flashing) – module waiting for configuration settings to be loaded.

5. Installation



Disconnect power before making any electrical connections.

It is not advisable to power up the module if the antenna is not connected.

The installation to which the module is to be connected should be provided with:

- **2-pole disconnecter,**
- **short-circuit protection with a 16 A time delay circuit breaker.**

The GSM-X LTE module should be installed indoors, in spaces with normal air humidity. When selecting the mounting location, remember that thick masonry walls, metal partitions, etc. will reduce the range of radio signal. It is not advisable to install the module in close vicinity to electrical installations, because this can result in malfunctioning of the device.

5.1 Preparing the cabling

Run the cables to be used for connecting the module with other devices to the module installation place. Do not lay the cables in immediate vicinity of the low-voltage electrical network wires, especially those used for supplying the high-power equipment (such as electric motors).

It is recommended that unshielded non-twisted cable to be used.

5.2 Installation of enclosure

The GSM-X LTE module is sold complete with the OPU-2B enclosure.

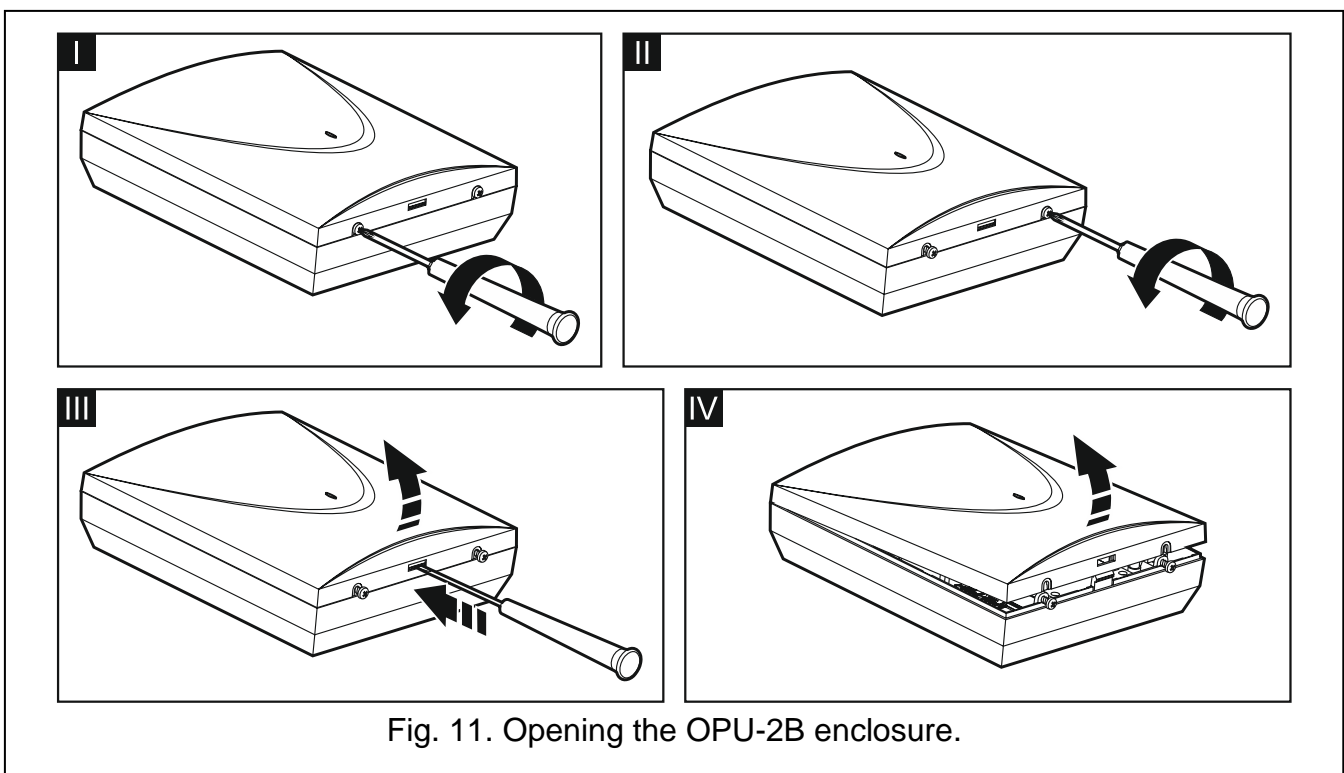

Fig. 11. Opening the OPU-2B enclosure.



The module can also be installed in SATEL's OPU-4 P enclosure. It is recommended that you use this enclosure, if you are planning to install the GSM-X-ETH Ethernet module / the GSM-X-PSTN telephone module on the electronics board or the module is to be supplied from a power supply unit connected to the APS connector (e.g. APS-412). If the module is installed in the OPU-4 P enclosure, skip the description below and follow instructions contained in the enclosure manual.

1. Loosen the screws locking the enclosure cover and remove the cover (Fig. 11).
2. Put the enclosure against the wall and mark the position of mounting holes.
3. Drill holes for wall plugs (screw anchors) in the wall.
4. Make an opening or openings in the enclosure base for lead-in cables.
5. Run the cables into the enclosure.
6. Using wall plugs (screw anchors) and screws, fasten the enclosure base to the wall. Select wall plugs and screws specifically intended for the mounting surface (different for concrete or brick wall, different for plaster wall, etc.).

5.2.1 Elements inside the enclosure

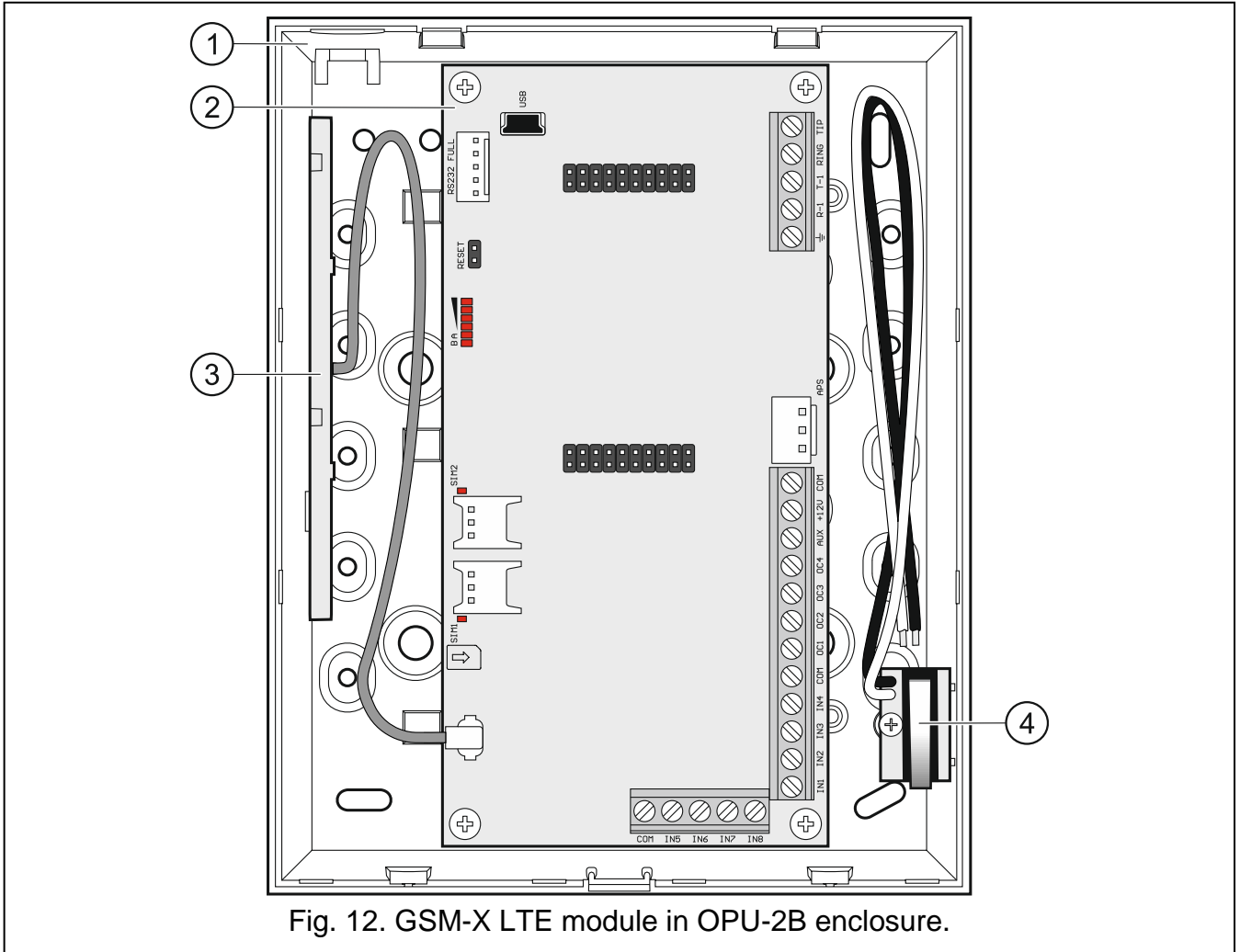

Fig. 12. GSM-X LTE module in OPU-2B enclosure.

- ① enclosure base.
- ② electronics board.
- ③ antenna.
- ④ tamper switch that can be connected to one of the module inputs.

5.3 Installation of antenna

The GSM-X LTE module is delivered with an antenna installed inside the enclosure. The antenna can be replaced with an external antenna mounted on the enclosure or at some distance from it. If this is the case, you will need the IPX-SMA adapter.

Using the antenna mounted at some distance from the enclosure is recommended wherever thick masonry walls, metal partitions etc. may decrease the range of radio signal at the module installation place.

The antenna must not be installed in parallel to low-voltage electrical wires, or it can affect performance of the antenna.

5.4 Connecting the analog telephone line



The module works only with the analog telephone line.

Do not connect any other telephone device between the module and the incoming telephone line.

Let the user know how the module is connected to the telephone network.

Connect the incoming telephone line to terminals TIP and RING (Fig. 13). Any telephone devices located in the premises (telephone, fax, etc.) can be connected to terminals T-1 and R-1.

If the ADSL service is used on the premises where the module is installed, the module should be connected after the ADSL filter, and the other devices using the analog telephone line should be connected to the module (Fig. 14).

To protect the telephone communicator against over-voltage, connect the \perp terminal to the protective earth conductor (PE) of the 230 VAC mains. To make the connection, use a conductor with $\geq 0,75 \text{ mm}^2$ cross-section. Never connect the \perp terminal to the neutral conductor (N).

Additionally, if the GSM-X-PSTN module is to be installed, see „GSM-X-PSTN module installation” p. 21.

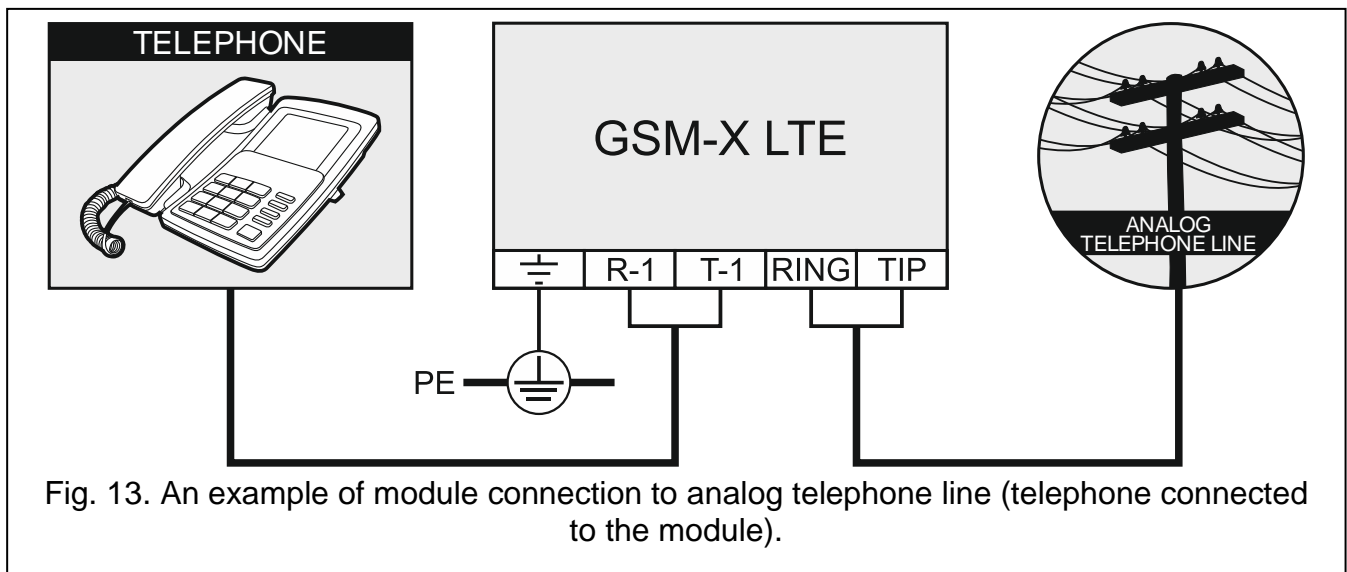

Fig. 13. An example of module connection to analog telephone line (telephone connected to the module).

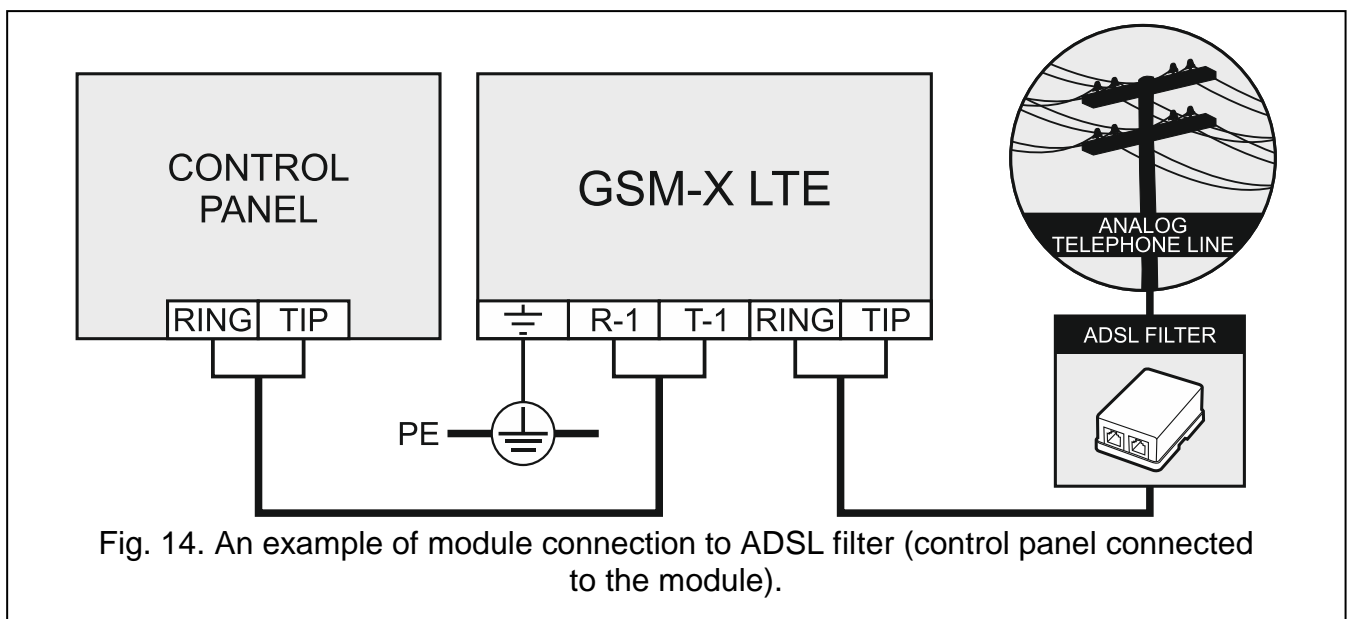

Fig. 14. An example of module connection to ADSL filter (control panel connected to the module).

5.5 Connecting the devices to the inputs and outputs

1. Connect the devices whose operation is to be monitored by the module to the input terminals.

2. Connect the devices which are to be controlled by the module to the terminals of OC type outputs.



The sum of currents drawn by devices powered from the AUX output must not exceed 300 mA.

5.6 Connecting the RS-232 port

If the module is to work in conjunction with the INTEGRA / INTEGRA Plus control panel, connect together the RS-232 ports on module and control panel. To connect the module PIN5 connector to the control panel RJ connector, use the RJ/PIN5 cable offered by SATEL.

If the module is to work in conjunction with the STAM-2 monitoring station, connect the module RS-232 port to the port of computer on which the cards are installed. If the computer has a RS-232 port, make a connection according to Fig. 15. If the computer has a USB port, use the USB-RS converter available from SATEL.

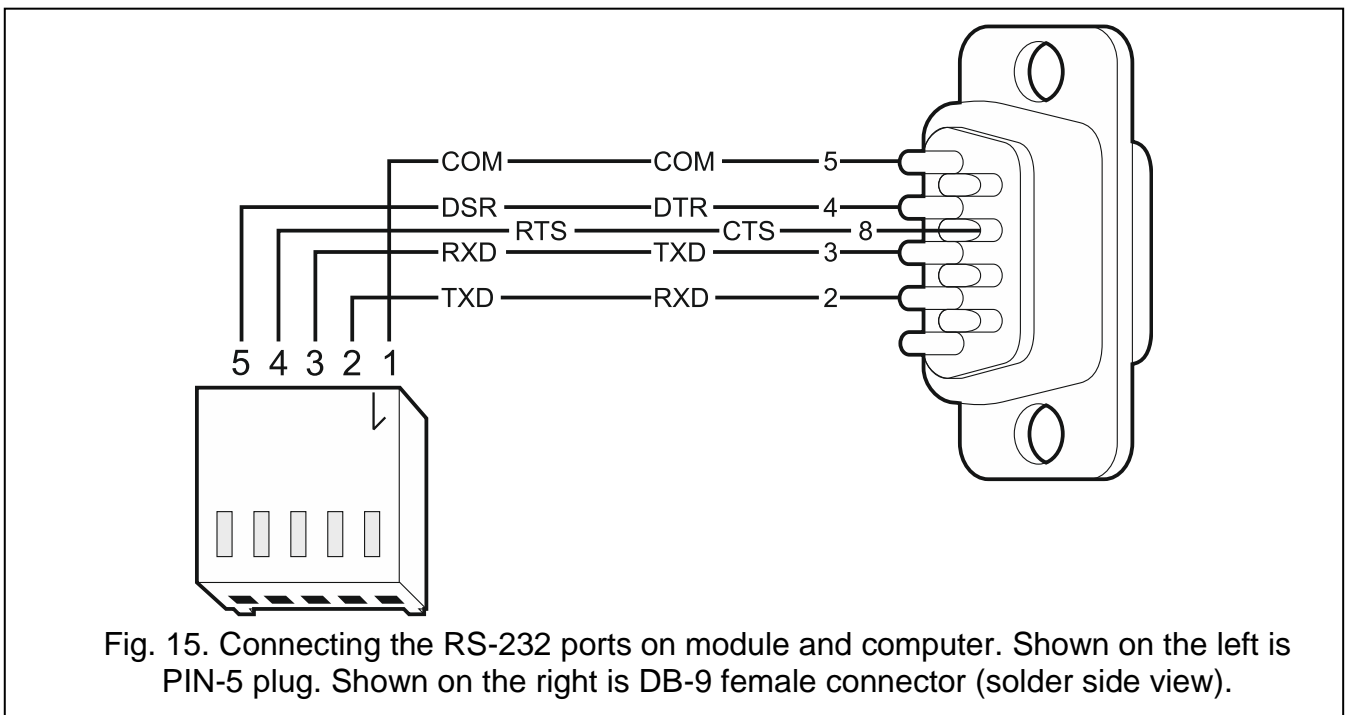

5.7 Connecting the power supply and starting the module

The module may be powered from the control panel, from an expander with power supply, or from a power supply unit. SATEL offers power supplies (e.g. APS-412), which can be connected to the APS connector on the electronics board.



When the supply voltage drops below 9.8 V, restart of the module occurs.

The required output current of power supply is at least 1 A (provided that no device is powered from the module AUX output).

1. Depending on the selected method of module powering, connect the power supply unit to the APS connector or connect the power leads to the +12V and COM terminals (use flexible conductors with a cross-section of 0.5-0.75 mm², or rigid conductors with a cross-section of 1-2.5 mm²).



Never connect power supply to APS connector and terminals at the same time.

2. Power up the module. The module will start up.

5.8 Connecting the computer to the module

Connect the computer to the module USB MINI-B connector. Having connected the computer to the module, you can:

- configure the module by using the GX Soft program. You can download the GX Soft program from the www.satel.eu website. It can be installed on computers with WINDOWS VISTA/7/8/10 operating system. For more information, please refer to section “Configuring” (p. 22).
- update the module firmware.

5.9 Installing the SIM cards

You can install up to two nano-SIM cards in the module.

1. If PIN code(s) is / are required by the SIM card(s), use the GX Soft program to program the code(s) (see p. 33).
2. Power down the module.
3. Insert the SIM card / cards into the socket / sockets (Fig. 16).

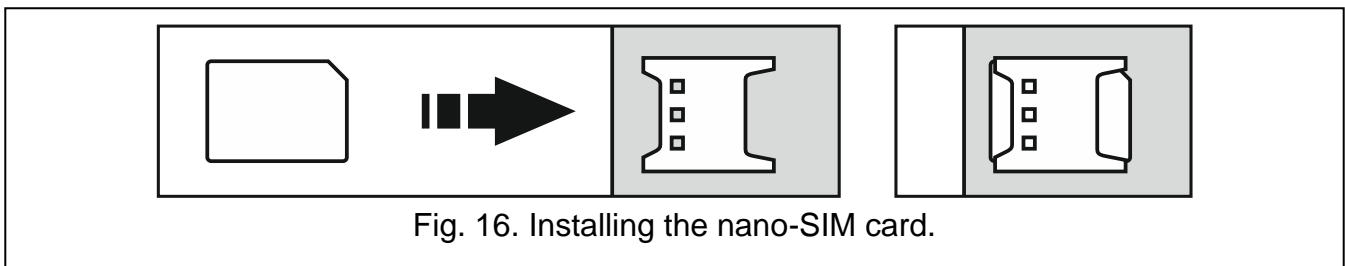

Fig. 16. Installing the nano-SIM card.

4. Power up the module. Logging the telephone into the cellular network may take a few minutes.



If the module is to send data via the cellular network, it is recommended that you use SIM cards with a dedicated tariff plan for M2M (machine-to-machine) communication.

If the programmed PIN code is invalid, the module will report a trouble. Programming a correct PIN code will clear the trouble.

Restarting the module with a wrongly programmed PIN code three times will block the SIM card. To unblock the SIM card, remove it and insert into a mobile phone. Then, enter the PUK code.

6. GSM-X-ETH Ethernet module

The GSM-X-ETH Ethernet module enables the GSM-X LTE module to be expanded by adding the Ethernet link. Using Ethernet, you can:

- send event codes to the monitoring station,
- configure the settings of GSM-X LTE module from the GX Soft program,
- configure the settings of INTEGRA / INTEGRA Plus control panel connected to the GSM-X LTE module from the DLOADX program,
- administer the INTEGRA / INTEGRA Plus control panel connected to the GSM-X LTE module from the GUARDX program,
- download new firmware for the GSM-X LTE or GSM-X-ETH module from the “UpServ” update server.

6.1 Electronic boards

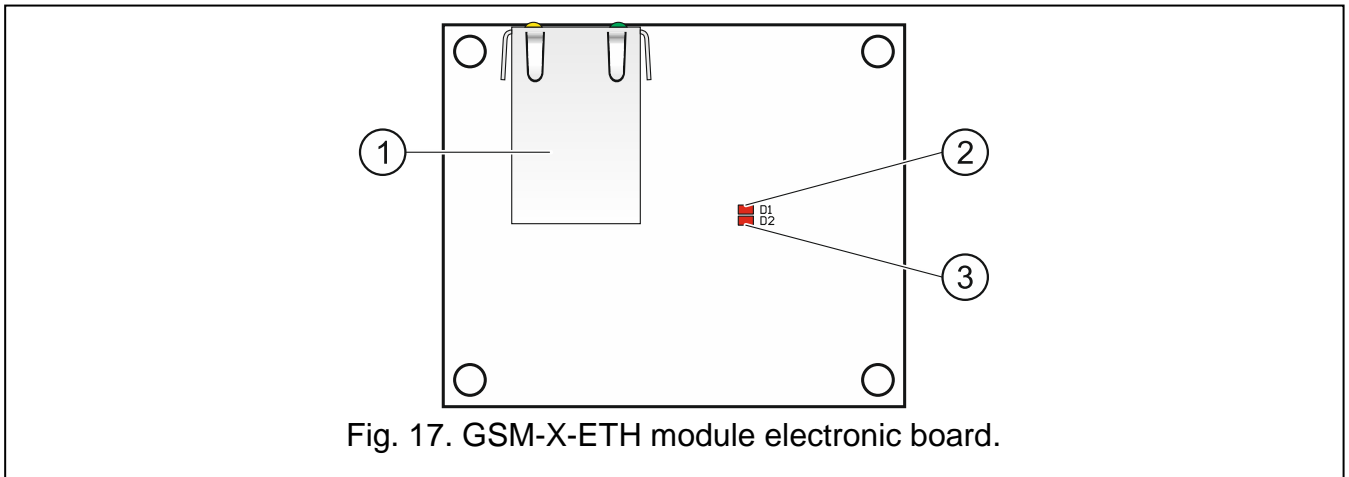

Fig. 17. GSM-X-ETH module electronic board.

- ① RJ-45 connector for Ethernet network. It is provided with two LEDs:
green – ON when control panel is connected to network,
yellow – flashing during data transmission.
- ② D1 LED indicating the current status of module connection with the Ethernet network:
flashing – module communicates with Ethernet,
ON – Ethernet cable connected to the RJ-45 connector,
OFF – Ethernet cable disconnected or no Ethernet communication.
- ③ D2 LED indicating the current status of module connection with the GSM-X LTE module:
flashing – communication with GSM-X LTE module OK,
OFF – no communication with GSM-X LTE module. Make sure that the “GSM-X-ETH/PSTN” option, “GSM-X-ETH/PSTN” tab, is enabled (see p. 35).

6.2 GSM-X-ETH module installation



The device is designed to be used only in the local area networks (LAN). It must not be connected directly to the public computer network (MAN, WAN). For establishing connection with public networks, use a router or xDSL modem.

1. Use the GX Soft program to configure settings of the GSM-X-ETH Ethernet module (see p. 35).
2. Power down the GSM-X LTE module.
3. Install the GSM-X-ETH Ethernet module in the connectors on the GSM-X LTE module electronics board (Fig. 18).
4. Connect the Ethernet cable to the RJ-45 connector on GSM-X-ETH module. Use a 100Base-TX standard compliant cable, identical to that used for connecting computers to the network.
5. Power up the GSM-X LTE module.

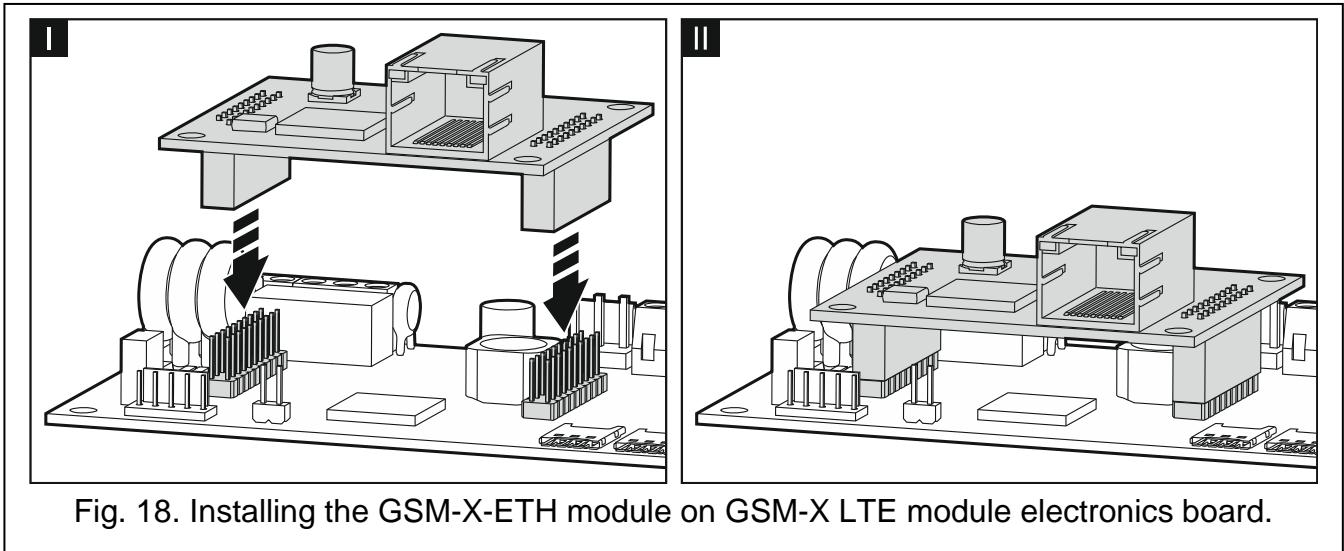

Fig. 18. Installing the GSM-X-ETH module on GSM-X LTE module electronics board.

7. GSM-X-PSTN telephone module

The GSM-X-PSTN module sends event codes to the monitoring station via analog telephone line (AUDIO reporting).

7.1 Electronics board

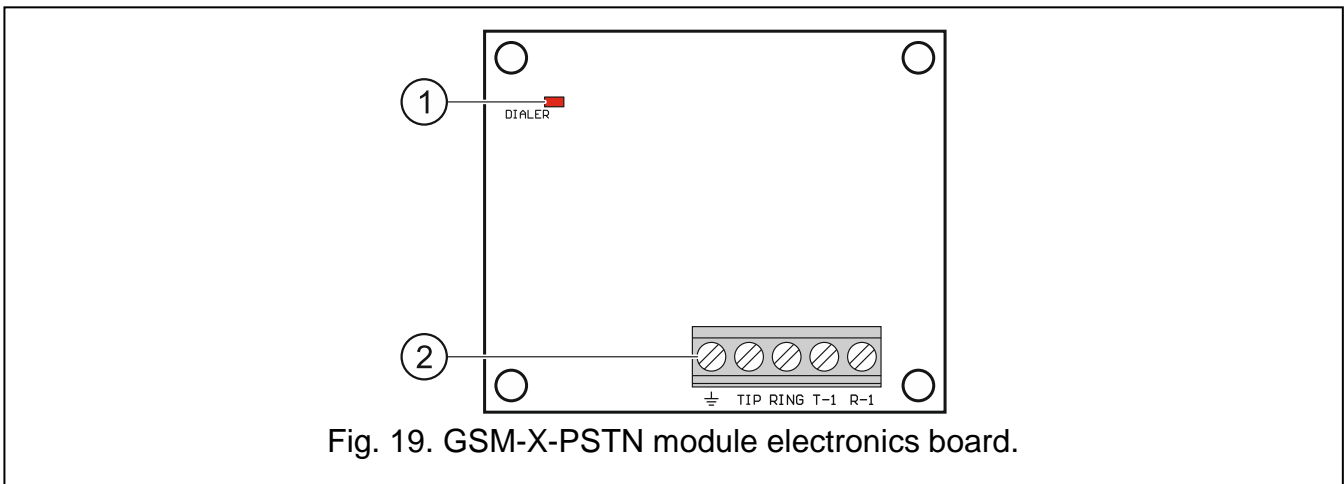

Fig. 19. GSM-X-PSTN module electronics board.

- ① DIALER LED indicating the current module status:
 - flashing – module working correctly,
 - OFF – no connection with GSM-X LTE module. Make sure that the “GSM-X-ETH/PSTN” option, “GSM-X-ETH/PSTN” tab, is enabled (see p. 35).
- ② terminals:
 - ⏏ – protective terminal of telephone module (to be connected only to the PE protective earth circuit of 230 VAC mains).
 - TIP, RING** – analog telephone line input (from telephone provider).
 - T-1, R-1** – analog telephone line output (for connecting the GSM-X LTE module).

7.2 GSM-X-PSTN module installation



The module works only with the analog telephone line.

Do not connect any other telephone device between the module and the incoming telephone line.

Let the user know how the module is connected to the telephone network.

1. Use the GX Soft program to enable the GSM-X-PSTN telephone module support (see p. 35).
2. Power down the GSM-X LTE module.
3. Install the GSM-X-PSTN module in the connectors on the GSM-X LTE module electronics board (Fig. 20).

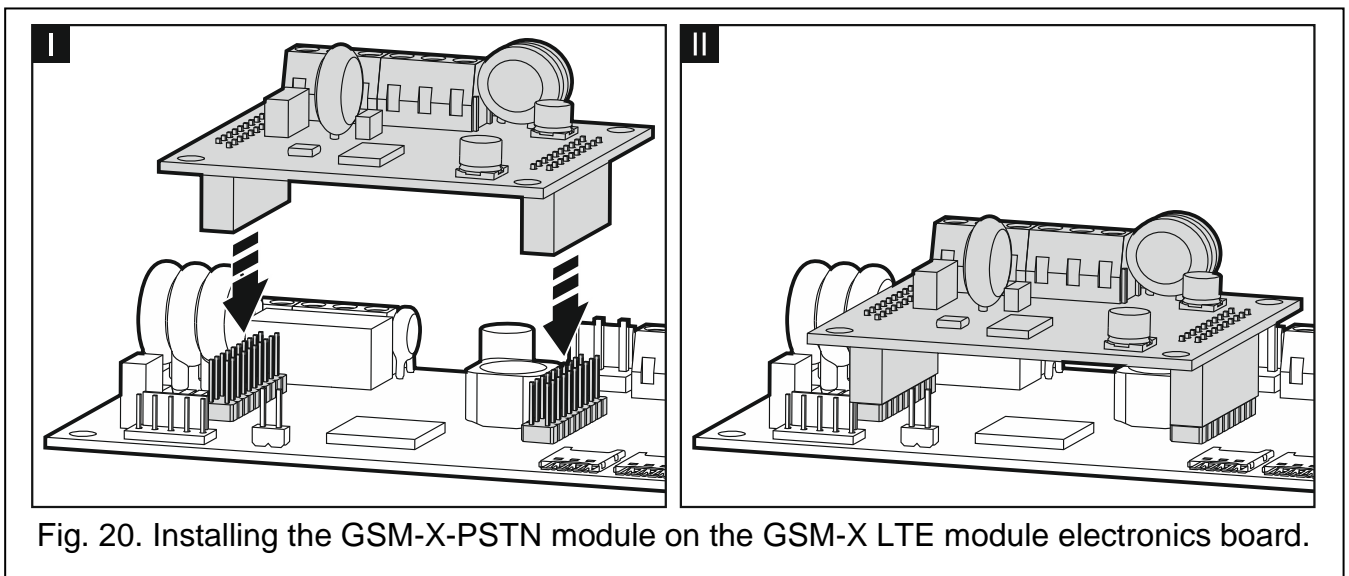

4. Connect terminals T-1 and R-1 of the module to terminals TIP and RING of the GSM-X LTE module (Fig. 21).
5. Connect the incoming telephone line to terminals TIP and RING. If the ADSL service is used on the premises, the module should be connected after the ADSL filter (Fig. 21).
6. Connect terminals T-1 and R-1 of the GSM-X LTE module to terminals TIP and RING of the control panel (Fig. 21). Any telephone located on the premises can be connected to terminals T-1 and R-1 of the control panel.

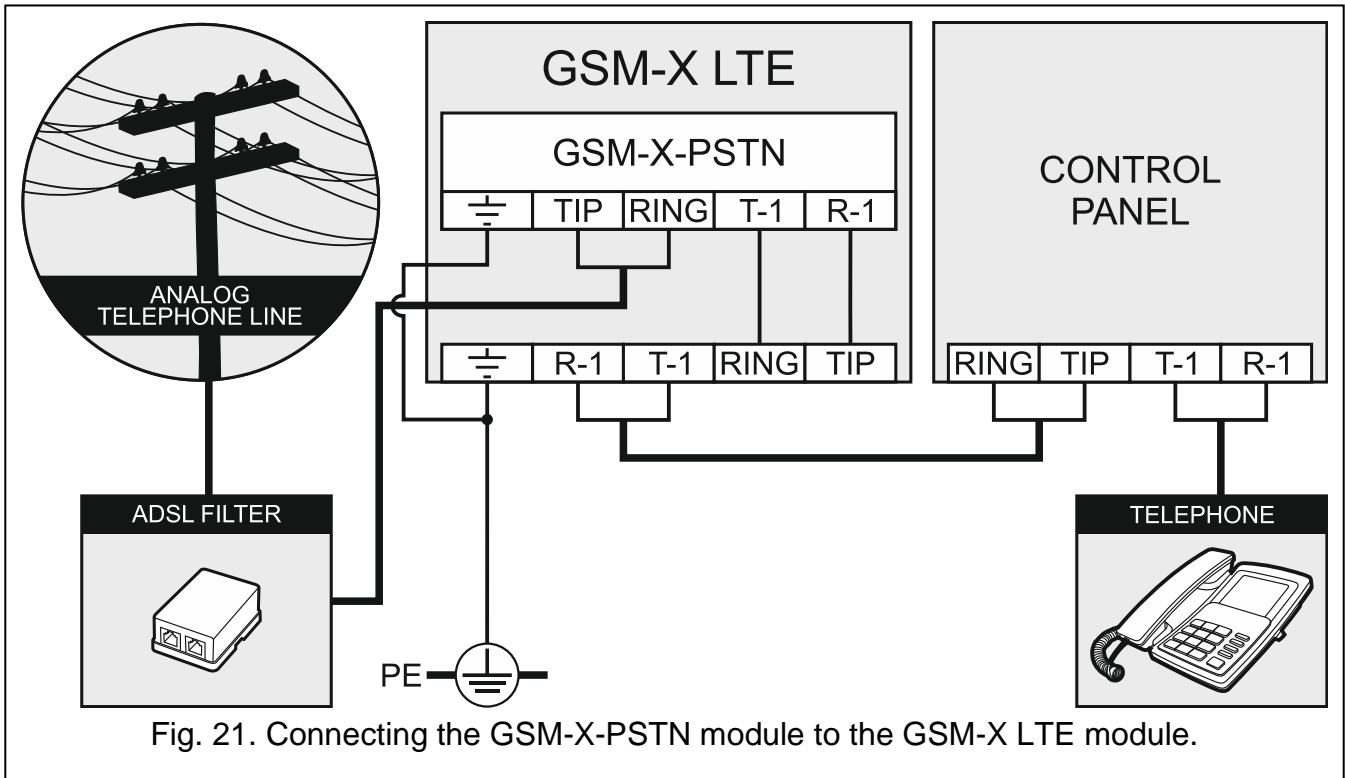

Fig. 21. Connecting the GSM-X-PSTN module to the GSM-X LTE module.

7. Connect terminals \perp of the GSM-X LTE and GSM-X-PSTN modules to the protective earth conductor (PE) of the 230 VAC mains (Fig. 21). To make the connection, use a conductor with $\geq 0.75 \text{ mm}^2$ cross-section. Never connect the \perp terminal to the neutral conductor (N).
8. Power up the GSM-X LTE module.

8. Configuring

You can configure all the module settings by using a computer with GX Soft program installed. Communication between the computer and the module can take place locally (via USB port) or remotely (via cellular network or, optionally, via Ethernet).

Module with factory settings can only be programmed locally. Remote programming is only possible after settings for communication via cellular network (see p. 32) or Ethernet (see p. 35) are configured. Communication between the program and the module is encrypted.

Having programmed the SMS control commands in the module (see "SMS/DTMF control" p. 53), you can configure some working parameters of the module by using SMS messages.

8.1 Description of the GX Soft program



In the WINDOWS VISTA or WINDOWS 7 system, provided the size of fonts and other screen elements is increased, the GX Soft program will be displayed correctly, if the "Use Windows XP style DPI scaling" option is disabled (the option is available when configuring the screen settings in the "Custom DPI Setting" window).

Access to the program can be password protected (see "Configuration" window" p. 27).

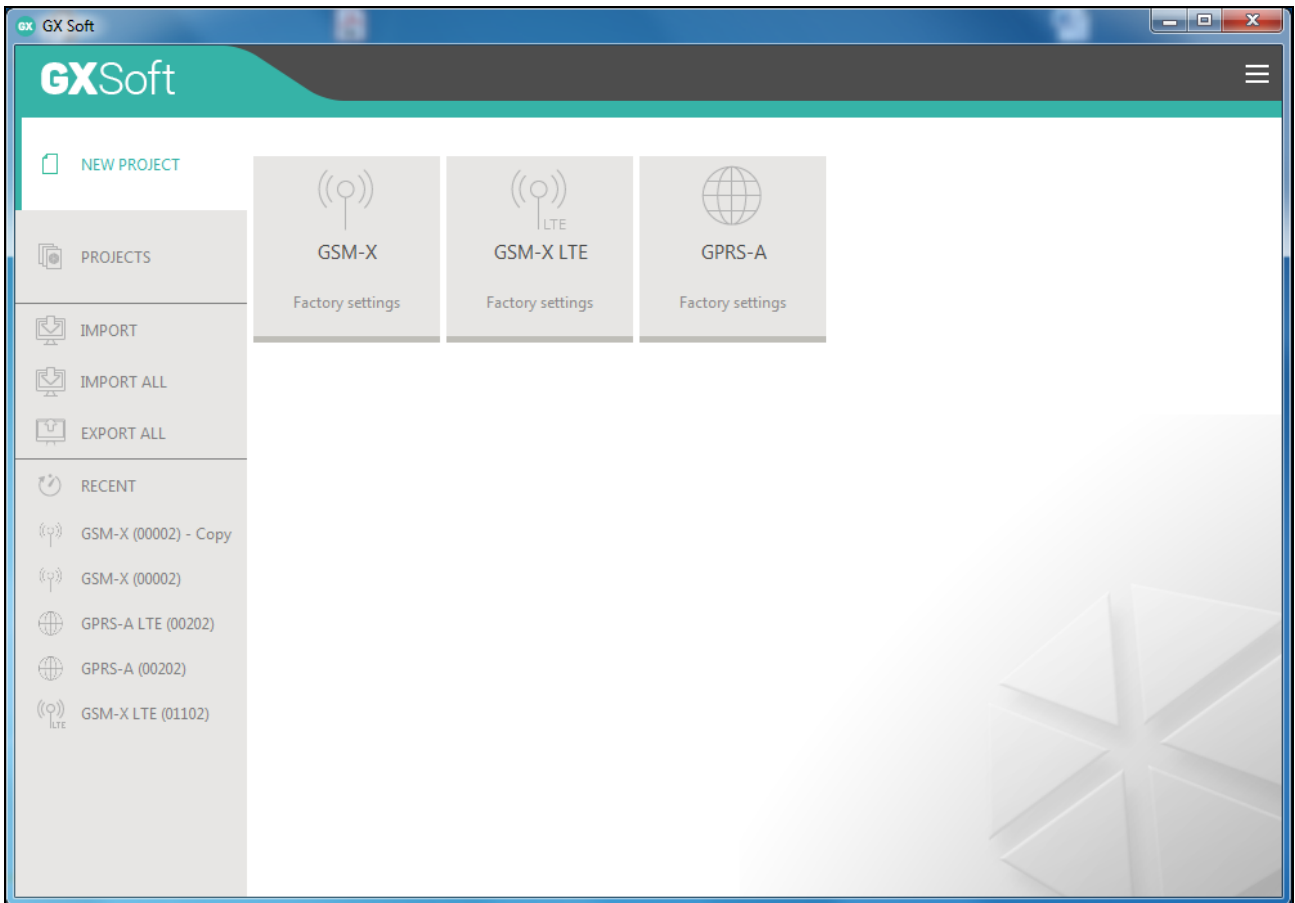

Fig. 22. GX Soft window when the program is run for the first time.

8.1.1 Menu bar in the GX Soft program

The menu bar is displayed in the top part of the program window. Appearance of the menu bar depends on the contents presented in the window.

Menu bar in the “Projects” tab





Fig. 23. Appearance of the menu bar when the “Projects” tab is displayed.

The search field is displayed on the menu bar. If you want to find a project file, click on the search field and start entering characters. The current view will be filtered out, based on the text entered.

Buttons

-  click, if the files are to be sorted by name (the arrow next to the button indicates whether the files from A to Z or from Z to A are displayed).

-  click, if the files are to be sorted by the time they were saved to disk (the arrow next to the button indicates whether the files are displayed in the descending or ascending order).

-  click, if the information about files is to be presented in brief version.

-  click, if the information about files is to be presented in full version.

-  click to display additional menu.

Appearance of the menu bar when displaying the module data

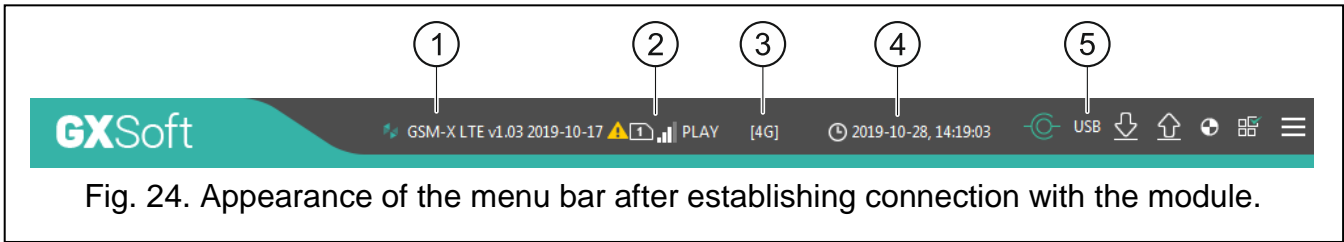









Fig. 24. Appearance of the menu bar after establishing connection with the module.

- ① type of module and firmware version.
- ② information about the SIM card used, cellular signal level and operator of the cellular network used by the module.
- ③ type of cellular network.
- ④ date and time according to the module clock (Greenwich Mean Time (GMT)).
- ⑤ information on the way of communication with the module:
 USB – local connection,
 TCP – remote connection (cellular network or Ethernet network).

Buttons

	click to display the list of troubles.
	click to establish connection to the module. The button is displayed when the program is not connected to the module.
	click to finish connection to the module. The button is displayed when the program is connected to the module.
	click to read data from the module.
	click to write data to the module.
	click to start test transmission to monitoring station.
	click to display information on the status of inputs and outputs. The button is active after connection to the module is established.
	click to display additional menu.

8.1.2 Side menu

The side menu is displayed on the left side of the program window. Appearance of the menu depends on the contents presented in the window.

The side menu before the module data are displayed

New project – click to display the “New project” tab.

Projects – click to display the “Projects” tab.

Import – click to import the file with module settings.

Recent – the list of recently opened files. Click on the name of the file to open it.

“New project” tab

The tab displays the files with default settings of the GSM-X, GSM-X LTE and GPRS-A modules (common to GPRS-A and GPRS-A LTE modules).

“Projects” tab

The tab displays the files saved to the computer disk, containing data of the supported modules.

The side menu after the module data are displayed

After the file with module data is opened or connection with the module is established, the side menu will display buttons which open the tabs used for configuration of the module settings.

8.1.3 Additional menu

The additional menu is displayed after you click on . Appearance of the menu depends on the contents presented in the window.

Open – click to display the “Projects” tab.

Save – click to save the module data to the computer disk.

Export – click to export the file with module data.

Connection – click to open the “Connection” window.

Configuration – click to open the “Configuration” window.

About – click to display information about the program.

Licence agreement – click to show the license agreement.

“Connection” window

In the window, you can choose how connection with the module is to be established:

- if the module is to be programmed locally from the computer connected to the module USB port, select “Local connection”,
- if the module to be programmed remotely through SATEL server (cellular network or Ethernet, when the GSM-X-ETH module is connected), select “Remote connection: SATEL server”,
- if the module to be programmed remotely (cellular network or Ethernet, when the GSM-X-ETH module is connected), but the module is to connect directly to the program, select “Remote connection: Module>>GX Soft”.

Module key – a string of characters for identification of the module. It must be identical to that programmed in the module (see “Communication” p. 38). Click on  to see the key.

Local connection

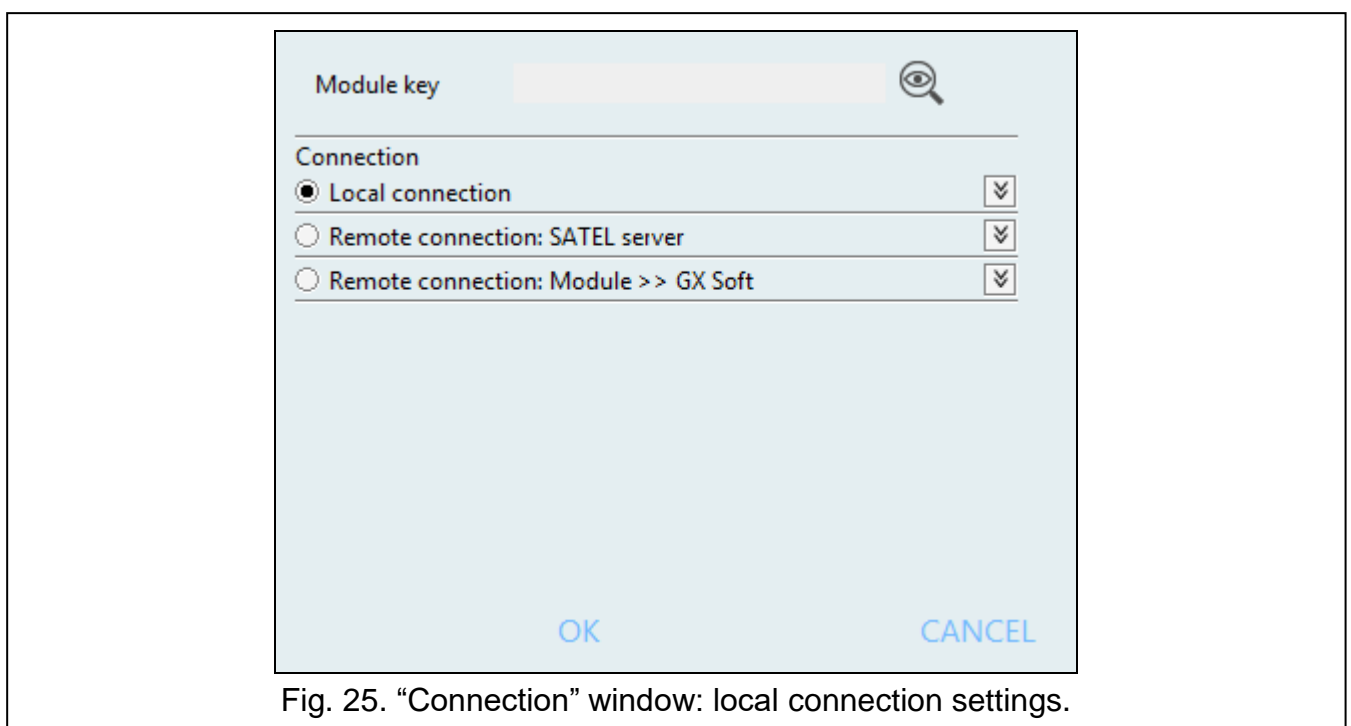

Fig. 25. “Connection” window: local connection settings.

GSM-X module – you can select the GSM-X LTE module to which the GX Soft program will connect. Click to display the list of all modules connected to the computer’s USB port.

Refresh – click to refresh the list of modules connected to the computer.

Remote connection: SATEL server

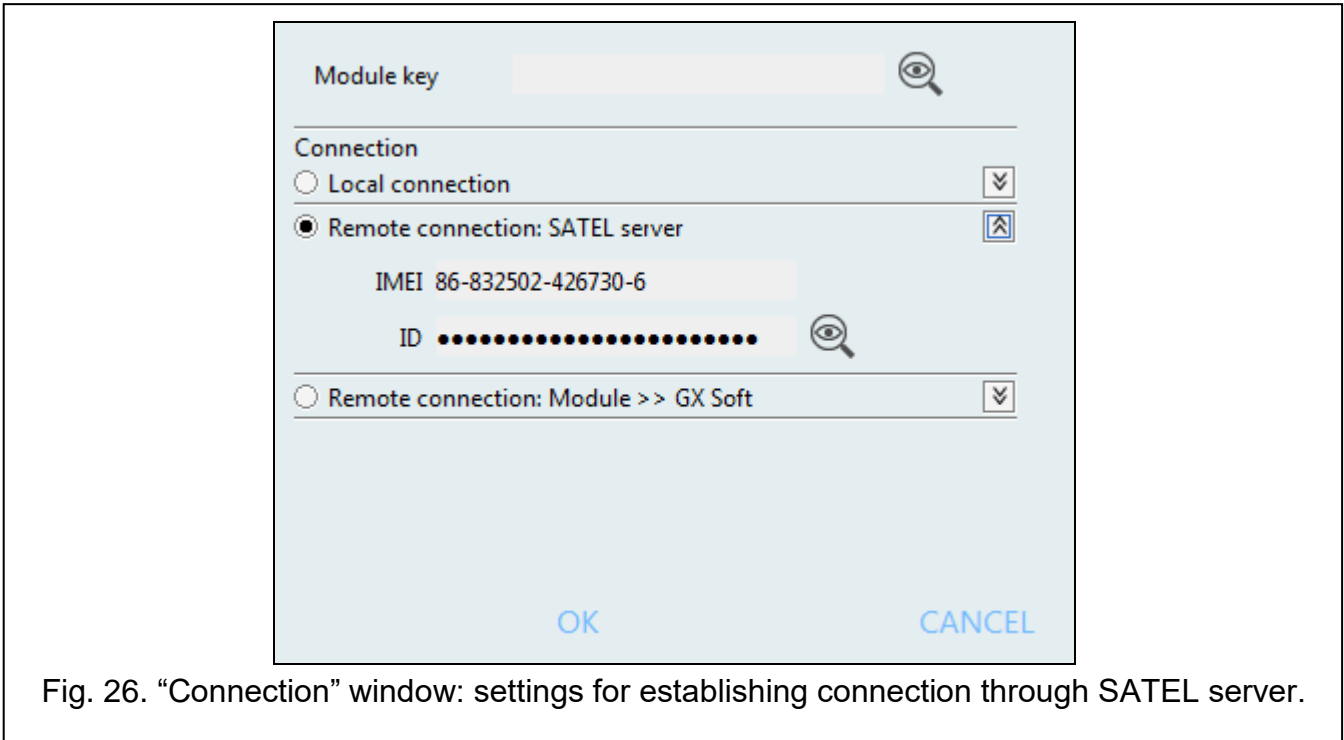



Fig. 26. "Connection" window: settings for establishing connection through SATEL server.

IMEI – individual identification number of the module cellular telephone.

ID – individual identification number for the purposes of communication through the SATEL server. The number is assigned automatically by the SATEL server during the first connection to the server (before the number is assigned, "F" characters are displayed). Click on  to see the ID.

Remote connection: Module>>GX Soft

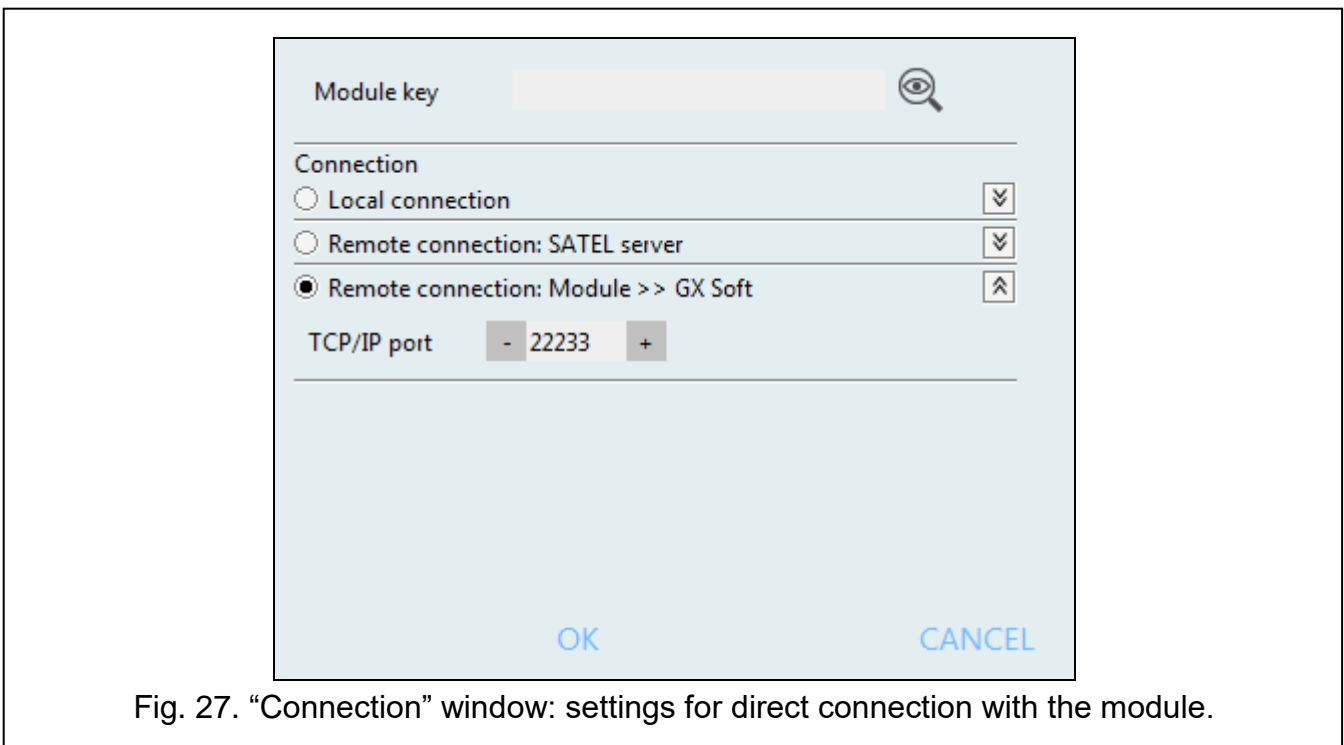

Fig. 27. "Connection" window: settings for direct connection with the module.

TCP/IP port – number of the port on which the computer with GX Soft program is awaiting the incoming connections from the module.

Buttons

OK – click to confirm the changes.

Cancel – click to close window without saving changes.

“Configuration” window

GX Soft password – if you want to protect the program against unauthorized access, you can enter the password. Click on  to see the password.

Confirm GX Soft password – enter the password to confirm it is correct. Click on  to see the password.

Application language – you can select a program language.

Buttons

Delete GX Soft password – click to delete the password.

Save – click to save changes.

Cancel – click to close window without saving changes.

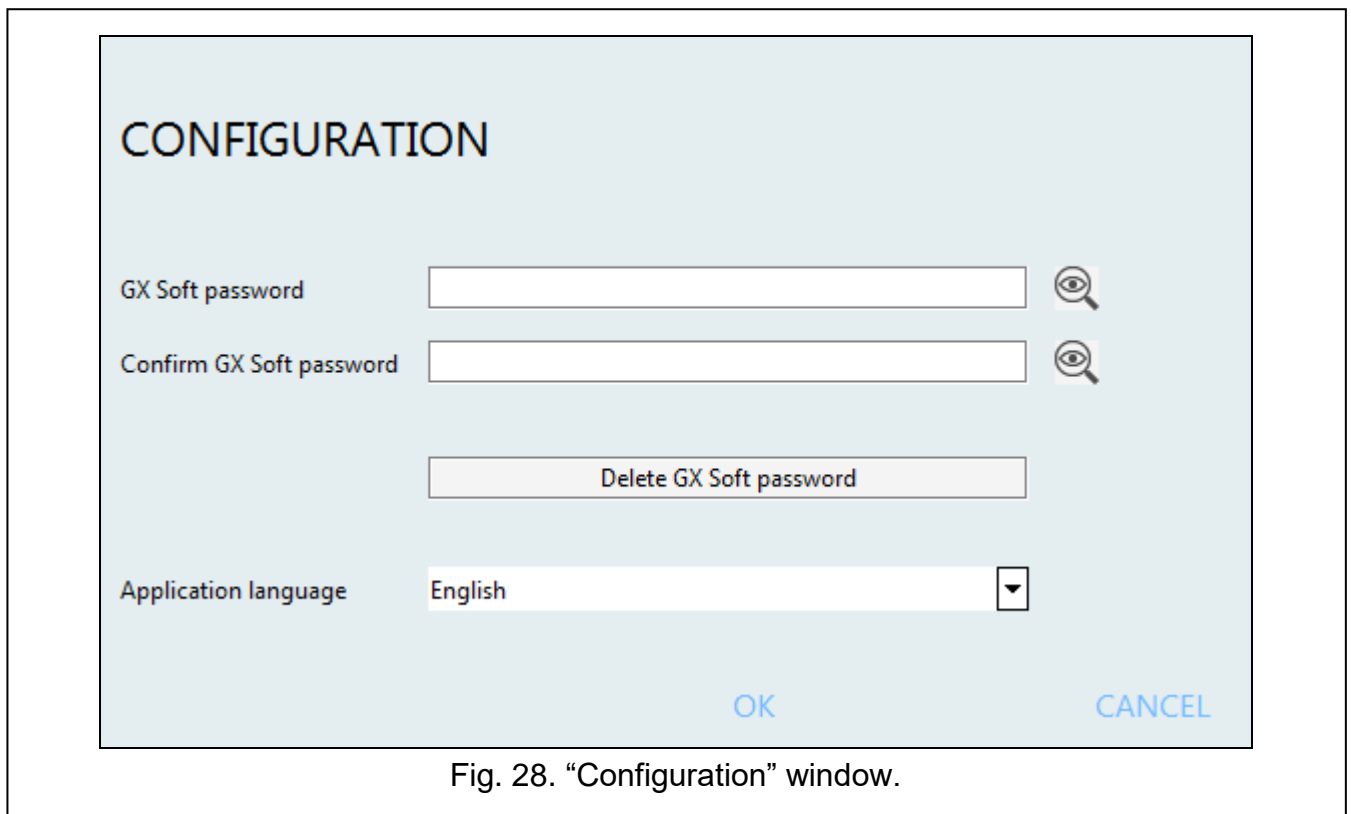

8.2 Establishing connection between the program and the module



Establishing connection is possible, if an identical “Module key” has been programmed in the module and in the program, except for the module with factory settings.

8.2.1 Local connection

1. Connect the module USB MINI-B socket with the computer USB port using the proper cable.

2. Open the file with module data (the file with default settings (“New project” tab) or the file saved on the computer disk (“Projects” tab)).
3. Configure the settings required to establish local connection (see ““Connection” window” p. 25).
4. Click  on the menu bar.
5. A window will open with information that connection has been established and a prompt to read the data.
6. Click “Yes” if you want to read the data stored in the module.

8.2.2 Remote connection: SATEL server



The “Connect to GX Soft” option must be enabled in the module (see “Communication” p. 38). By default, this option is disabled.

1. Open the file with module data (the file with default settings (“New project” tab) or the file saved on the computer disk (“Projects” tab)).
2. Configure the settings required to establish connection through the SATEL server (see ““Connection” window” p. 25).
3. Click  on the menu bar.
4. A window will open with information that connection has been established and a prompt to read the data.
5. Click “Yes” if you want to read the data stored in the module.

8.2.3 Remote connection: Module>>GX Soft



The computer running the GX Soft program must have a public IP address.

Communication can take place via the cellular network or the Ethernet network, if the GSM-X-ETH module is connected to the GSM-X LTE module.

A control command, after receiving of which the module will make an attempt to establish connection, must be programmed in the module (see “Direct connection to GX Soft” p. 39).

1. Open the file with module data (the file with default settings (“New project” tab) or the file saved on the computer disk (“Projects” tab)).
2. Configure the settings required to establish direct connection (see ““Connection” window” p. 25).
3. Click  on the menu bar.
4. Send an SMS message with the following content to the number of SIM card currently used by the module:
 - xxxx** (“xxxx” – control command that initiates establishing connection with the GX Soft program) – the module is to connect to the computer whose address has been programmed in the module,
 - xxxx=aaa:p=** (“xxxx” – control command that initiates establishing connection with the GX Soft program; “aaa” – address of the computer running the GX Soft program; “p” – TCP port) – the module is to connect to the computer whose address has been given in the SMS message and use for communication the TCP port given in the SMS message. The “Server address from SMS” option must be enabled in the module (p. 39).
5. After the module connects to the computer, a window will open with information that connection has been established and a prompt to read the data.
6. Click “Yes” if you want to read the data stored in the module.

8.3 Project

The tab allows entering data for easier identification of the project created.

Project name – individual name of the project.

Owner – name of the project owner.

Address – project owner address data.

Contact telephone – project owner contact telephone number.

Module telephone numbers (SIM 1/ SIM 2) – telephone numbers of SIM cards installed in the module.

Notes – additional information / notes stored in the project.

Module – type and version of the module firmware.

IMEI – individual identification number of the module cellular telephone.

ID – individual identification number of the module for the purposes of communication through the SATEL server (assigned automatically by the SATEL server).



– click the button to open the window in which the QR code is displayed. The QR code contains information required when configuring settings of communication through the SATEL server. You can read the QR code by using a mobile device or export to PNG file and transmit to the users. The QR code facilitates configuring the GX Control application settings.

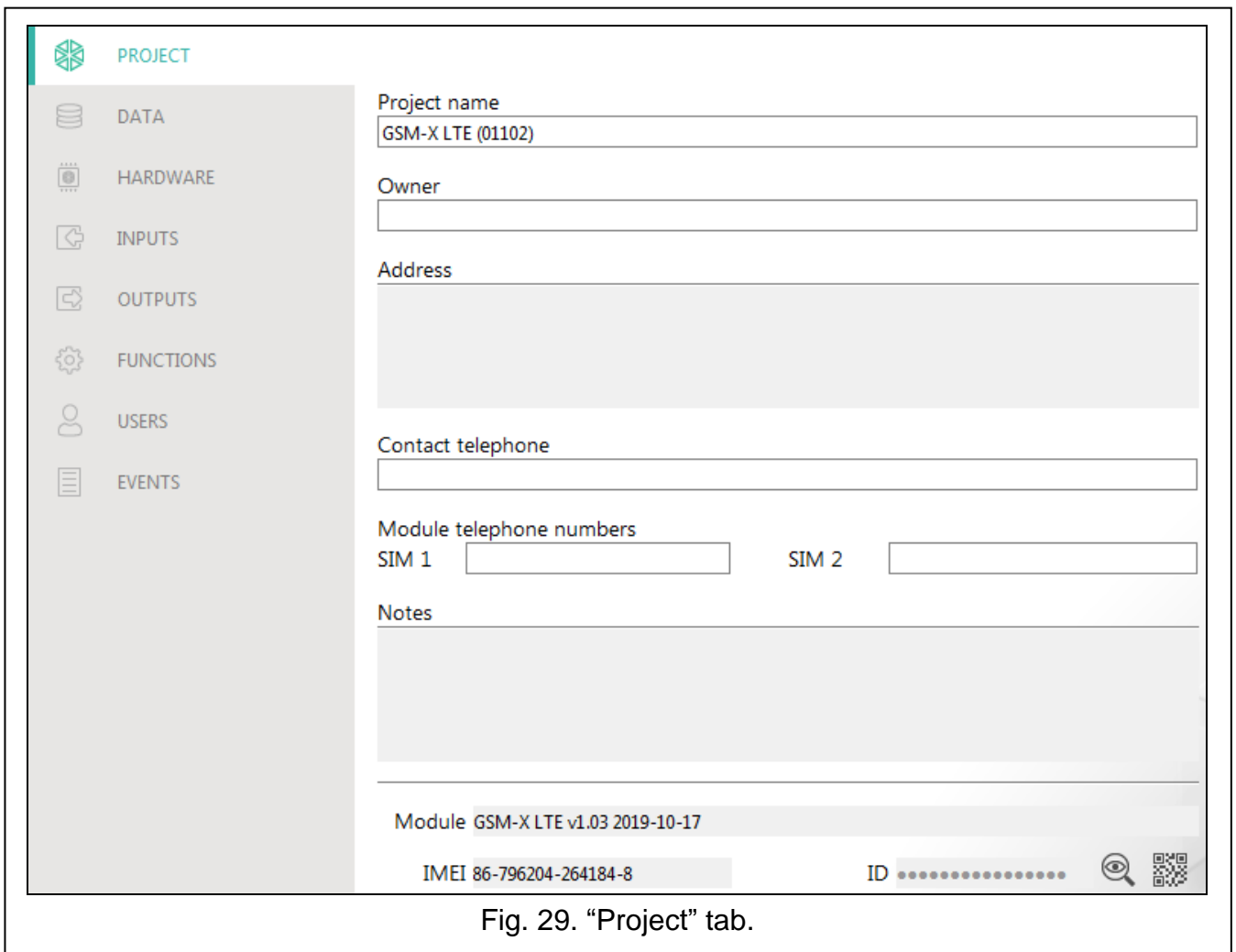

Fig. 29. "Project" tab.

8.4 Data

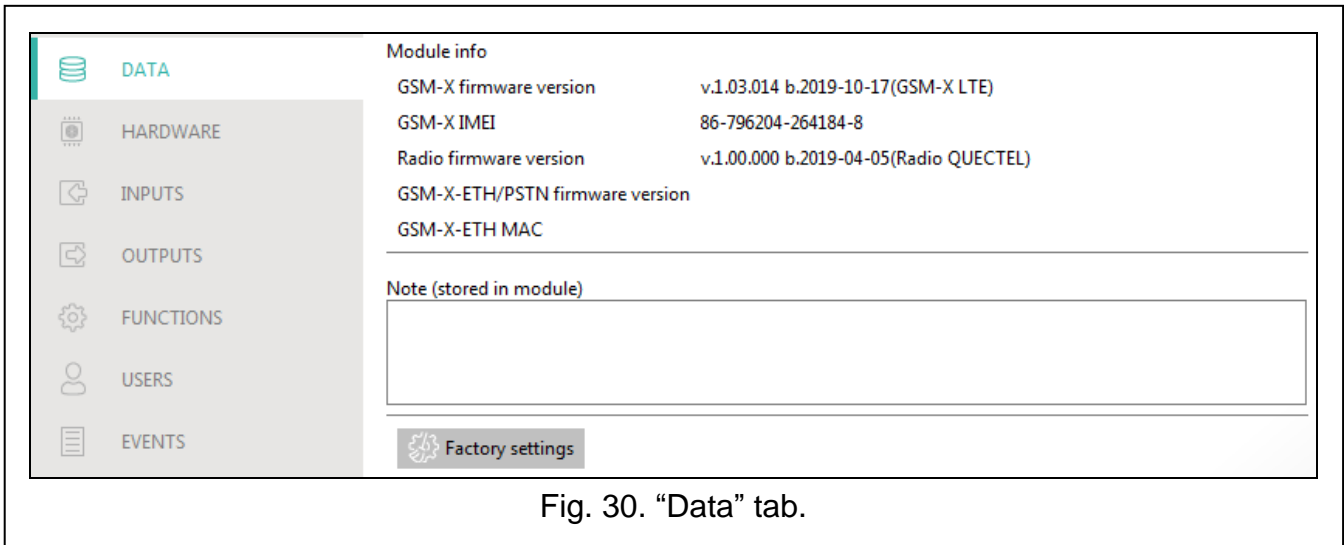

Fig. 30. "Data" tab.

Module info

GSM-X firmware version – version number of module firmware.

GSM-X IMEI – individual identification number of the module cellular telephone.

Radio firmware version – version number of radio firmware.

GSM-X-ETH/PSTN firmware version – firmware version number of the GSM-X-ETH or the GSM-X-PSTN module (if connected to the GSM-X LTE module).

GSM-X-ETH MAC – MAC number of the GSM-X-ETH module (if connected to the GSM-X LTE module).

Note (stored in module) – additional information / notes stored in module memory.

Factory settings – click to restore module factory settings. A message box will be displayed in which you must confirm your intention to restore the factory settings of the module.

8.5 Hardware

8.5.1 Mainboard

Module language – you can select the language in which the module will communicate with the GX Soft program and GX Control application. Default names of inputs, outputs, users and descriptions of events will be displayed in the language selected, regardless of the language version of the program (see "Configuration" window" p. 27) and application.

RS-232 mode

INTEGRA / STAM-2 / Data Forwarding – if this option is enabled, the module can be used in conjunction with the INTEGRA / INTEGRA Plus control panel, STAM-2 monitoring station or another device connected to the RS-232 port.

AT commands – if this option is enabled, the module can be used as an external modem. The module starts working in the modem mode on receiving the AT command, and stops working in this mode when the DTR signal is lost.



Do not enable the "AT commands" option, if the module is working in conjunction with the INTEGRA / INTEGRA Plus control panel or STAM-2 monitoring station (the device is connected to the module RS-232 port).

GSM identifier – a sequence of up to 6 alphanumeric characters to identify the module during communication with the STAM-2 monitoring station. Connection between

the station and the module can only be established when the identifiers in program and module are identical. The factory default value: AAAAAA. Click on  to see the characters sequence.

RS-232 baud rate – the rate of data transfer through the RS-232 port. The factory default setting: 19200.

Telephone line loss delay – the time after which the module will signal the loss of analog telephone line. Values from 0 to 99 minutes can be programmed. Programming the value 0 means that the module will not signal any trouble.

GSM network loss delay – the time after which the module will signal the cellular telephone trouble. Values from 0 to 99 minutes can be programmed. Programming the value 0 means that the module will not signal any trouble.

GSM signal problem delay – the time after which the module will report any problem with the cellular signal (e.g. signal jamming / interference). You can program from 0 to 30 seconds. The delay is set to 15 seconds by default.

Ringing time – the time during which the incoming cellular call can be answered by the device connected to the telephone line output. After this time has elapsed, the control from the telephone keypad (DTMF) will be available. Termination of the connection before this time elapses is interpreted as CLIP. Values from 0 to 99 seconds can be programmed.



It is recommended that the voice mail be disabled.

Fig. 31. “Mainboard” tab.

Time synchronization



The module uses the Greenwich Mean Time (GMT), not the local time (the time zones are not taken into account).

NTP – if this option is enabled, the module clock is synchronized with the time server.

GSM – if this option is enabled, the module clock is synchronized with the time of cellular network operator.

NTP server – time server address. The field is available if the “NTP” option is enabled. You can enter the IP address or domain name.

Get time using – you can select a channel for communication with the time server:

GPRS – cellular network.

GSM-X-ETH/GPRS – Ethernet network or cellular network. Ethernet has priority. Cellular network is used if there is no Ethernet communication.

GSM-X-ETH – Ethernet network.

Communication over the Ethernet network is possible when the GSM-X-ETH module is installed. The field is available if the “NTP” option is enabled.

Tel. numbers verification (SMS/DTMF control and answer to CLIP)

Allowed tel. numbers (GSM Gateway) – if this option is enabled, SMS and DTMF control is possible from the telephones on the “Allowed tel. numbers” list (see “GSM gateway” p. 40). The module can also answer to CLIP from a telephone on that list.

Users tel. numbers – if this option is enabled, SMS and DTMF control is possible from user telephones (see “Users” p. 60). The module can also answer to CLIP from a user telephone.

No verification – if this option is enabled, the module can be controlled from any telephone. The module can also answer to CLIP from any telephone.

Answer to CLIP

The module offers the CLIP answering feature. CLIP means calling without establishing connection (you must hang up on hearing the ring signal), i.e. toll-free. The module will identify the phone number of the calling party and respond accordingly.

NONE – select this option if the module is not to answer to CLIP.

SMS – select this option if the module is to answer to CLIP using SMS message.

CLIP – select this option if the module is to answer to CLIP using CLIP.

Send SMS with module state on CLIP – if the option is enabled, in response to CLIP the module will send an SMS message with the module status information (see p. 65). If the option is disabled, the module will send “GSM-X CLIP” SMS message in response to CLIP.

CLIP starts test transmission – if the option is enabled, CLIP will start a test transmission.

Test transmissions



The module will send a test transmission if, when configuring the module events distribution, you define the monitoring station to which a test transmission is to be sent (see “Module events distribution” p. 48).

If option “Send test transmissions using all paths” (p. 48) is enabled, the test transmission is sent using all transmission paths included in the list that defines the order of using transmission paths (see “Reporting priority” p. 48).

On time (GMT) – select this option if the test transmission is to be sent every day at a specified time. Define the hour and minute.

Every – select this option if the test transmission is to be sent at specified time intervals. Define every how many days, hours and minutes.

8.5.2 GSM

SIM 1 / SIM 2 – if this option is enabled, the given SIM card is supported by the module. Disable the option, if the given card is not to be used. Disabling the option will prevent unnecessary reporting of troubles related to that card.

PIN – PIN code of the SIM card. Click on  to see the code.

i | *If an incorrectly programmed PIN code is used, the module will report a trouble and will be waiting until the correct PIN code is entered.*
Restarting the module with a wrongly programmed PIN code three times will block the SIM card. To unblock the SIM card, remove it and insert into a mobile phone. Then, enter the PUK code.

GPRS APN – access point name for Internet GPRS/LTE connection.

Username – user name for Internet GPRS/LTE connection.

Password – password for Internet GPRS/LTE connection.

DNS 1 server / DNS 2 server – IP address of DNS server to be used by the module. It is recommended to program the IP address of DNS server. The IP address is necessary for sending data via cellular network, if the address of the device the module is to connect to (monitoring station, computer with GX Soft program) is entered as a name.

i | *The data transfer settings can be obtained from the cellular network operator.*

SMS center number – telephone number of the short message service center. It is required if the module is to send / receive SMS messages. It is usually stored in the SIM card and you do not have to program it. If the number is not stored in the SIM card, enter the number required by the SIM card operator.

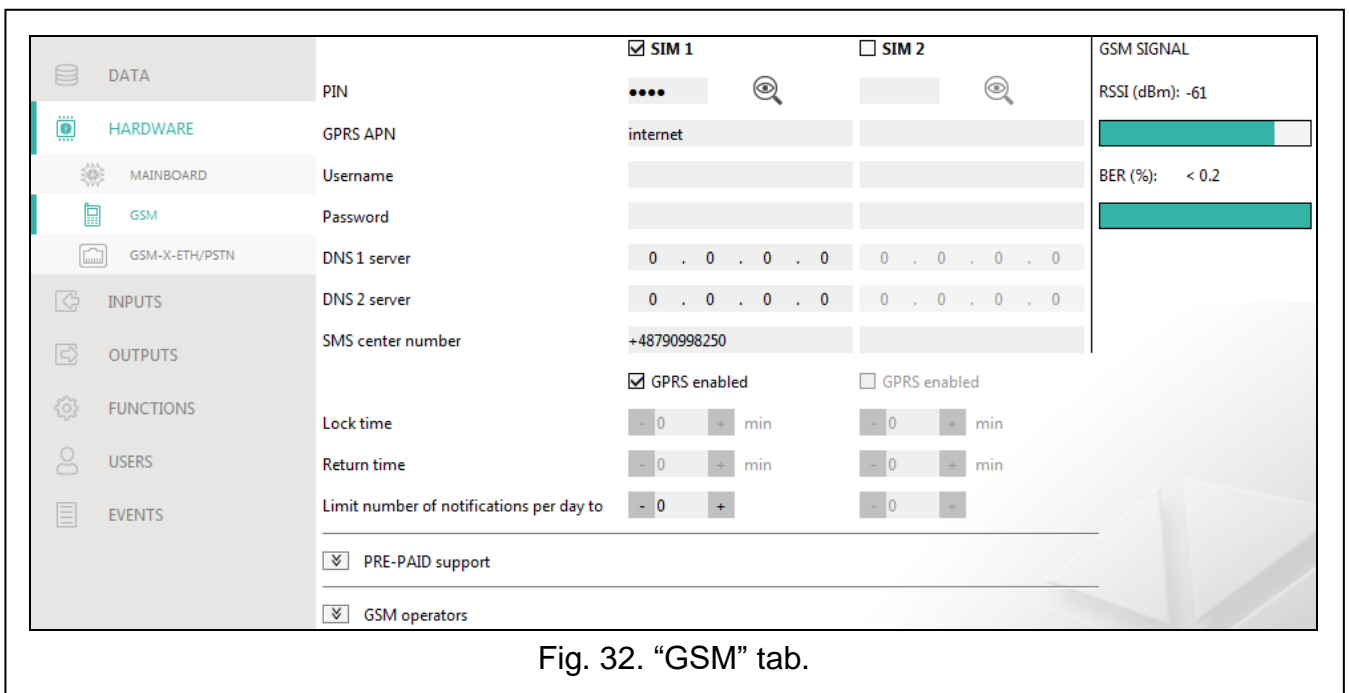

Fig. 32. “GSM” tab.

GPRS enabled – enable this option if the data are to be sent via cellular network. If the option is disabled, sending data via cellular network is not available.

Lock time – the time during which switch-over to the other SIM card is impossible. The time is counted from the moment of switch-over to the given card. For reporting, the transmission paths programmed as subsequent ones, if they require switch-over to the other card, will be skipped during the lock time countdown. Entering the value 0 means that instant switch-over to the other SIM card is possible.

Return time – the time after which the other SIM card is to be used. Entering the value 0 means that automatic switch-over to the other SIM card will not take place.

i | *If two SIM cards are to be used, one of them must be treated as the priority card. It is recommended that return time equal to 0 be programmed for it.*

Limit number of notifications per day to – this field allows you to specify the maximum number of transmissions (GPRS/LTE, SMS, CLIP) made by the module during a day. Values from 0 to 255 can be entered. Entering 0 means no transmission limit (default: 0).

PRE-PAID support

Check balance USSD code – the USSD code which is used to check balance of the SIM card account. If the code has been programmed, the module can check the SIM card account balance.

Minimum balance level – the minimum amount of funds on the SIM card account. If the amount of funds drops below the minimum level:

- trouble will be reported,
- where the SIM card account balance is checked automatically, information on the account balance will be sent as an SMS message to the phones of users for which the “Forward SMS” option is enabled (see “Users” p. 60).

Check balance every – the field defines every how many hours the module will perform the SIM card balance check. Entering 00:00 will disable the check.

GSM operators

Preferred network type – the type of network to which the SIM card is to log in. You may leave the default setting “Auto” (the module’s telephone will connect to any type of network) or force the SIM card to connect only to a selected type of network (2G, 3G or 4G).

MCC/MNC code – codes of the operator of cellular network to which the SIM card is to log in. Enter in turn:

- MCC (Mobile Country Code) – country code,
- MNC (Mobile Network Code) – operator code.

Remember that entering invalid data may make logging into the cellular network impossible. Unless you enter the code, the module will log into the SIM card operator network (“auto” option disabled) or into the network offering the best signal (“auto” option enabled).

auto – if this option is enabled and the module cannot log into the cellular network of the operator defined by means of the MCC/MNC code, it will log into the available cellular network.

Get GSM operators list – click on the button if you want to download the list of cellular network operators. When the list appears, select one of the available cellular network operators. The operator's codes will be entered automatically.

GSM SIGNAL

RSSI (dBm) – indicator of received radio signal strength.

BER (%) – bit error rate in digital transmission (the ratio of the number of errored bits to the total number of bits transmitted).

8.5.3 GSM-X-ETH/PSTN

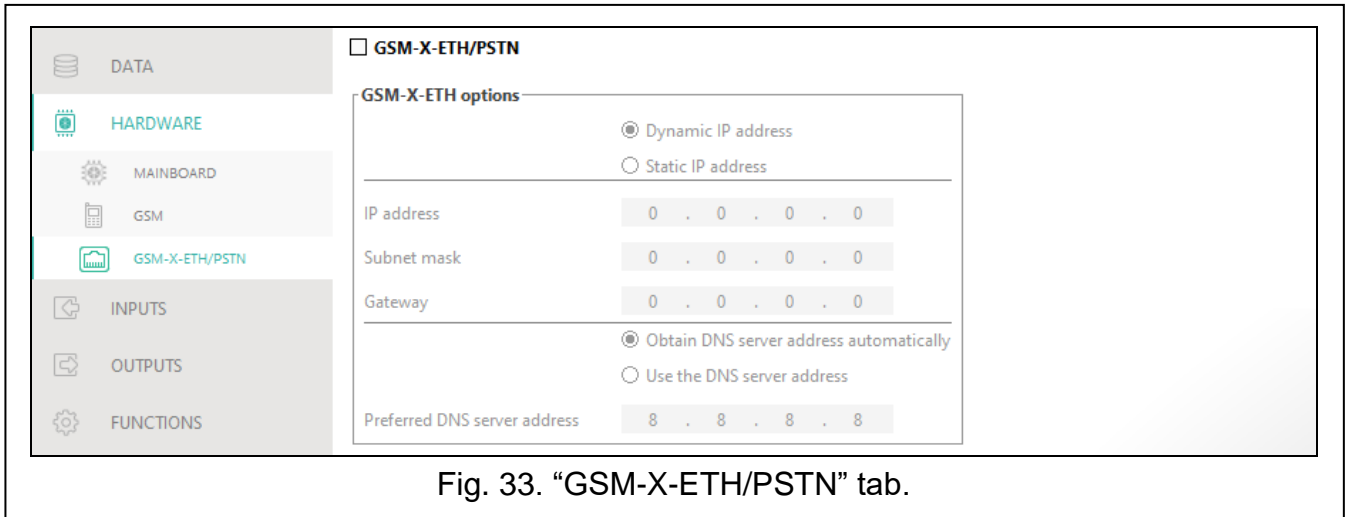

Fig. 33. “GSM-X-ETH/PSTN” tab.

GSM-X-ETH/PSTN – if this option is enabled, the GSM-X-ETH / GSM-X-PSTN module is supported by the GSM-X LTE.

Dynamic IP address – select this option if GSM-X-ETH module IP address, subnet mask and gateway are to be downloaded automatically from the DHCP server.

Static IP address – select this option if you want GSM-X-ETH module IP address, subnet mask and gateway to be entered manually.

IP address – GSM-X-ETH module IP address.

Subnet mask – the mask of the subnet in which the GSM-X-ETH module is working.

Gateway – IP address of the network device through which the other devices in the local network can communicate with devices in other networks.

Obtain DNS server address automatically – select this option if the GSM-X-ETH module is to download IP address of the DNS server automatically from the DHCP server.

Use the DNS server address – select this option if you want the IP address of DNS server to be entered manually.

Preferred DNS server address – IP address of the DNS server which is to be used by the GSM-X-ETH module.

8.6 Inputs

8.6.1 State

The numbers above the buttons correspond to the numbers of inputs.



input in normal state. Click to block the input.



input violated. Click to block the input.



input blocked. Click to unblock the input.

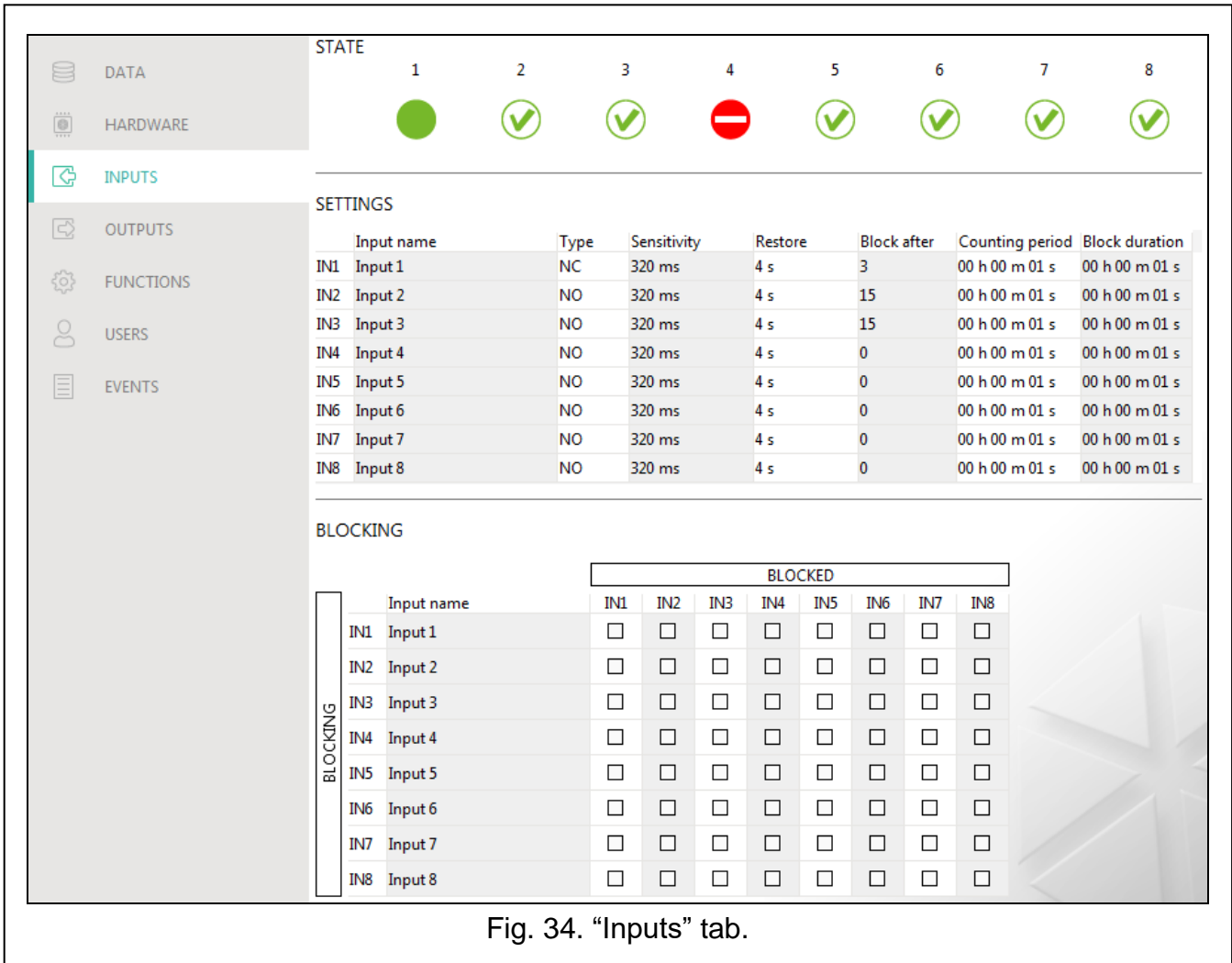

8.6.2 Settings

Input name – individual name of the input (up to 16 characters).

Type – you can program the input as NC (normally closed) or NO (normally open).

Sensitivity – the time during which the input must be violated, so that it can be noted by the module. You can enter from 20 ms to 5100 ms.

Restore – the time counted from the input restore, after which the module will recognize that the normal status of input is restored. You can program 4 seconds or 240 seconds.

Block after – the number of violations after which the input will be automatically blocked (the input is blocked after restore). You can program from 0 to 15. Value 0 means no blocking.

Counting period – the time after which the counter of violations programmed for the given input will be reset. You can program from 0 to 24 hours. Value 0 means that the violations will be counted without time limits.

Block duration – if the input is to be automatically blocked for a specific time period, it must be entered. You can program from 0 to 24 hours. Value 0 means that the given input will be blocked until unblocked by the user.

8.6.3 Blocking

You can indicate the input whose violation will block other inputs of the module. Blocking input violation restore means end of blocking. Each of the module inputs can block the other 7 inputs. The table lines present the blocking inputs, and the columns present the blocked

inputs. If you want the input violation to block the other module inputs, select the field at the intersection of the corresponding line and column.

8.7 Outputs

8.7.1 Control

The numbers correspond to the numbers of outputs.

1 OFF output inactive. Click to activate the output.

ON 1 output active. Click to deactivate the output.

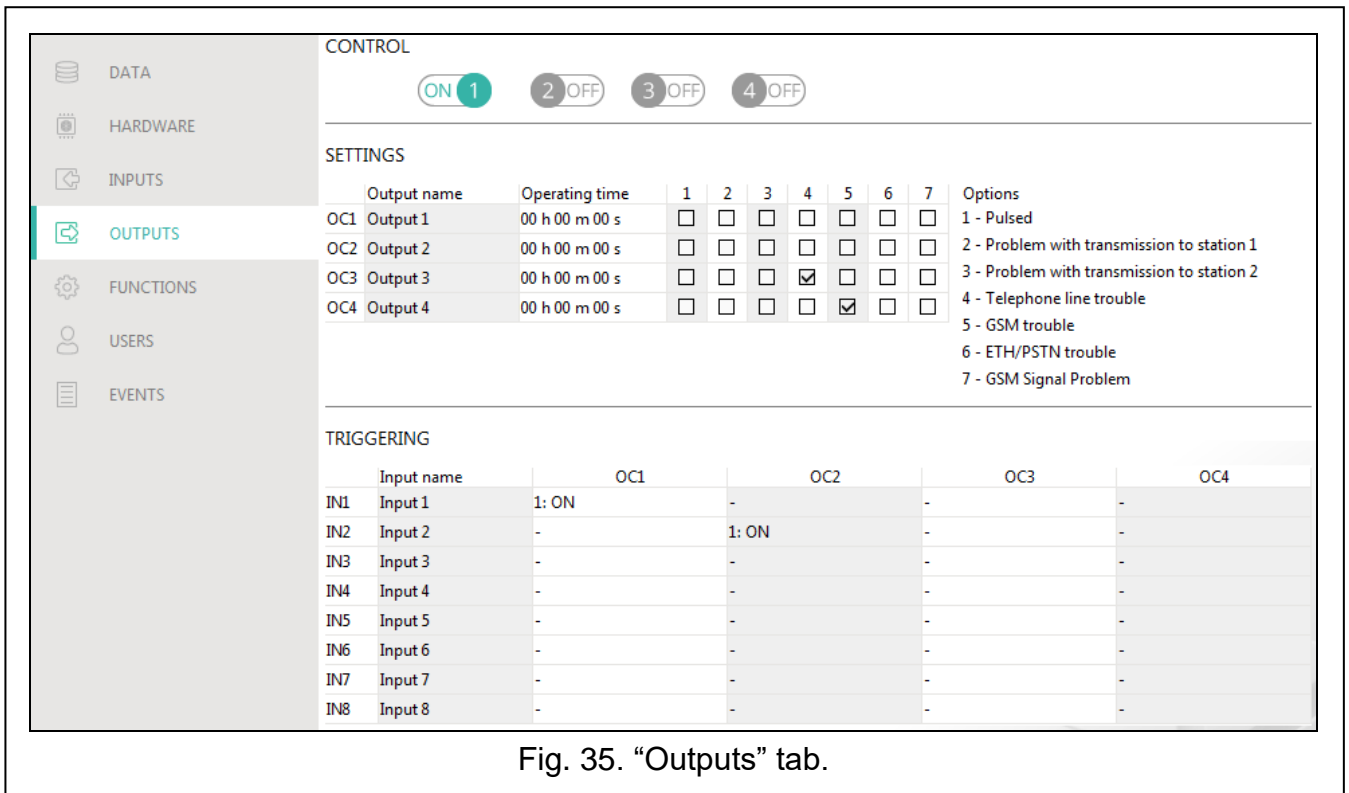

Fig. 35. "Outputs" tab.

8.7.2 Settings

Output name – individual name of the output (up to 16 characters).

Operating time – time during which the output is active. Entering "0" will keep the output in the same state until deactivated by the user.

Options

Pulsed – if this option is enabled, the output is pulsating when it is active.

Problem with transmission to station 1 / 2 – if this option is enabled, the output will be active in the case of any problem with transmitting events to the monitoring station 1 / 2.

Telephone line trouble – if the option is enabled, the output is active in case of the analog telephone line trouble. The time during which the problem must occur for the output to be activated can be defined in the "Mainboard" tab (see "Telephone line loss delay" p. 31).

GSM trouble – if this option is enabled, the output is active in case of a problem with logging into the cellular network. The time during which the problem must occur for the output to be activated can be defined in the "Mainboard" tab (see "GSM network loss delay" p. 31). The problem with logging into the cellular network can be caused by:

- missing SIM card,
- entering a wrong PIN code,

- missing or damaged antenna,
- unavailable cellular network (out of range),
- telephone damage.

ETH/PSTN trouble – if the option is enabled, the output is active in the case of any problem with the Ethernet network (e.g. GSM-X-ETH module failure) / the PSTN network (e.g. GSM-X-PSTN module failure).

GSM Signal Problem – if the option is enabled, the output is active in the case of any problem with the cellular signal (e.g. signal jamming / interference). The time during which the problem must occur for the output to be activated can be defined in the “Mainboard” tab (see: “GSM signal problem delay” p. 31).

8.7.3 Triggering

You can define whether and how the inputs are to control the outputs. The table lines present the inputs, and the columns present the outputs of the module. If you want the input violation to change the output state, select one of the available options in the selection field at the intersection of the corresponding line and column:

- – input does not control the output.

1: ON – violation of the input will activate the output.

2: OFF – violation of the input will deactivate the output.

3: ON FOR TIME – violation of the input will activate the output for the time programmed in the “Operating time” field (see p. 37).

4: TOGGLE – violation of the input will switch the output to its opposite state.

5: FOLLOW INPUT – violation of the input will activate the output, and restoration of the input will deactivate the output.

8.8 Communication

Module – type and version of the module firmware.

Module key – a string of characters for identification of the module. You can enter up to 16 alphanumeric characters (digits, letters and special characters). You can use spaces, but at least one character must be different from space. Do not program the same key for different modules. Communication between the GX Soft program and the module is possible if the keys in the program and the module are identical.

IMEI – individual identification number of the module cellular telephone.

ID – individual identification number for the purposes of communication through the SATEL server (assigned automatically by the SATEL server).

8.8.1 SATEL server

Connect to GX Control – if this option is enabled, it is possible to establish connection between the GX Control application and the module through the SATEL server.

Push notifications – if this option is enabled, the GX Control application can provide information about events by means of push notifications.

Connect to GX Soft – if this option is enabled, it is possible to establish connection between the GX Soft program and the module through the SATEL server.



Make sure that the SIM card tariff plan is suited to the requirements of communication via the SATEL server (connection to the server is active at all times).

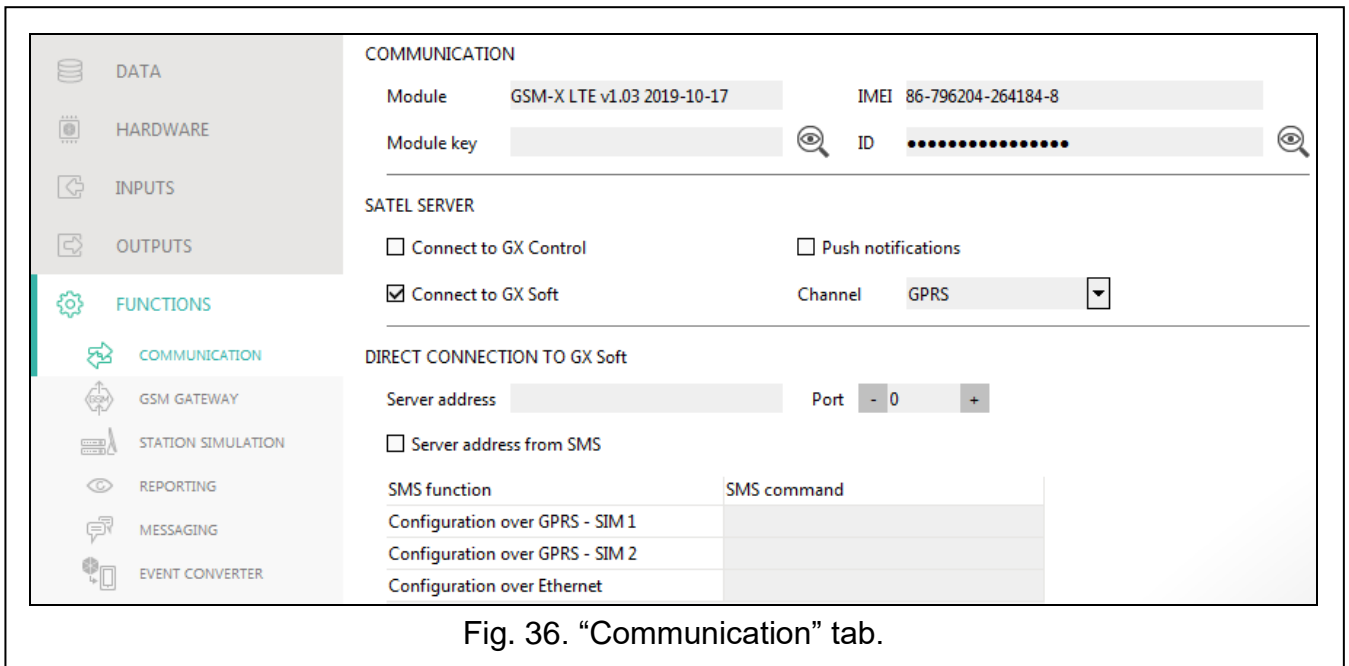

Fig. 36. "Communication" tab.

Channel – you can select a channel that will be used for communication between the module and the SATEL server:

GPRS – cellular network.

GSM-X-ETH/GPRS – Ethernet network or cellular network. Ethernet network has priority. Cellular network is used if there is no communication over the Ethernet network.

GSM-X-ETH – Ethernet network.

Communication using the Ethernet network is possible if the GSM-X-ETH module is installed.

8.8.2 Direct connection to GX Soft

Server address – address of the computer running the GX Soft program. It must be a public address. You can enter the IP address or domain name.

Port – number of the TCP port used for direct communication between the module and the computer with GX Soft program. You can enter values from 0 to 65535 (0=disabled).

Server address from SMS – if this option is enabled, the address of server, to which the module is to connect, and the port number can be entered in the content of SMS message initiating the connection. If the address is not entered, the module will connect to the computer whose address has been programmed in the module.

SMS function – the function that is run on receiving the control message. The functions are used to establish communication between the module and the GX Soft program:

Configuration over GPRS – SIM 1 – via cellular network using SIM1 card.

Configuration over GPRS – SIM 2 – via cellular network using SIM2 card

Configuration over Ethernet – via Ethernet network (when GSM-X-ETH module is installed).

SMS command – the control command which, if sent in the SMS message, will initiate communication between the module and the GX Soft program. You can enter up to 16 alphanumeric characters except spaces (digits, letters and special characters).



The content of control commands must vary.

The content of one control command must not be inserted into the content of another command.

In the SMS message, you can include address of the computer the module is to connect to, and the number of TCP port which is to be used for communication.

8.9 GSM gateway

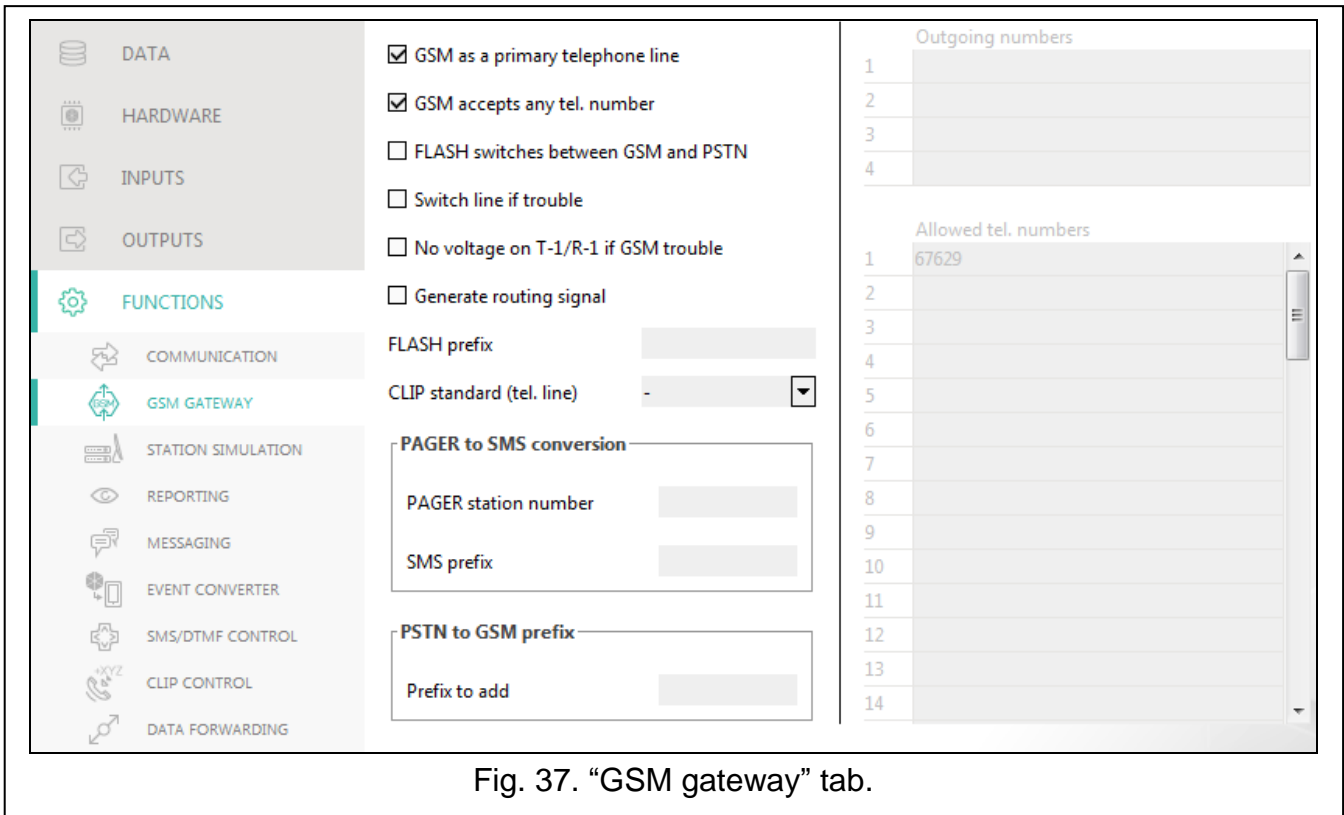

Fig. 37. "GSM gateway" tab.

GSM as a primary telephone line – if this option is enabled, the module cellular telephone is the primary communication path for devices connected to the telephone line output. If the option is disabled, the analog telephone line is the primary communication path.

GSM accepts any tel. number – if this option is enabled, the module cellular telephone can make calls to any number. If the option is disabled, the module cellular telephone can only make calls to the telephone numbers whose initial digits or whole numbers are programmed in the module (see "Allowed tel. numbers" p. 43).

Flash switches between GSM and PSTN – if this option is enabled, it is possible to switch between the primary and backup communication paths by using the FLASH key on the telephone connected to the telephone line output. To define the primary communication path, use the "GSM as a primary telephone line" option. In the example shown in Fig. 38, analog telephone line is used as the primary path. If, after picking up the receiver, before dialing the number, you press the FLASH key, the backup path will be used, i.e. cellular telephone (Fig. 38-II).

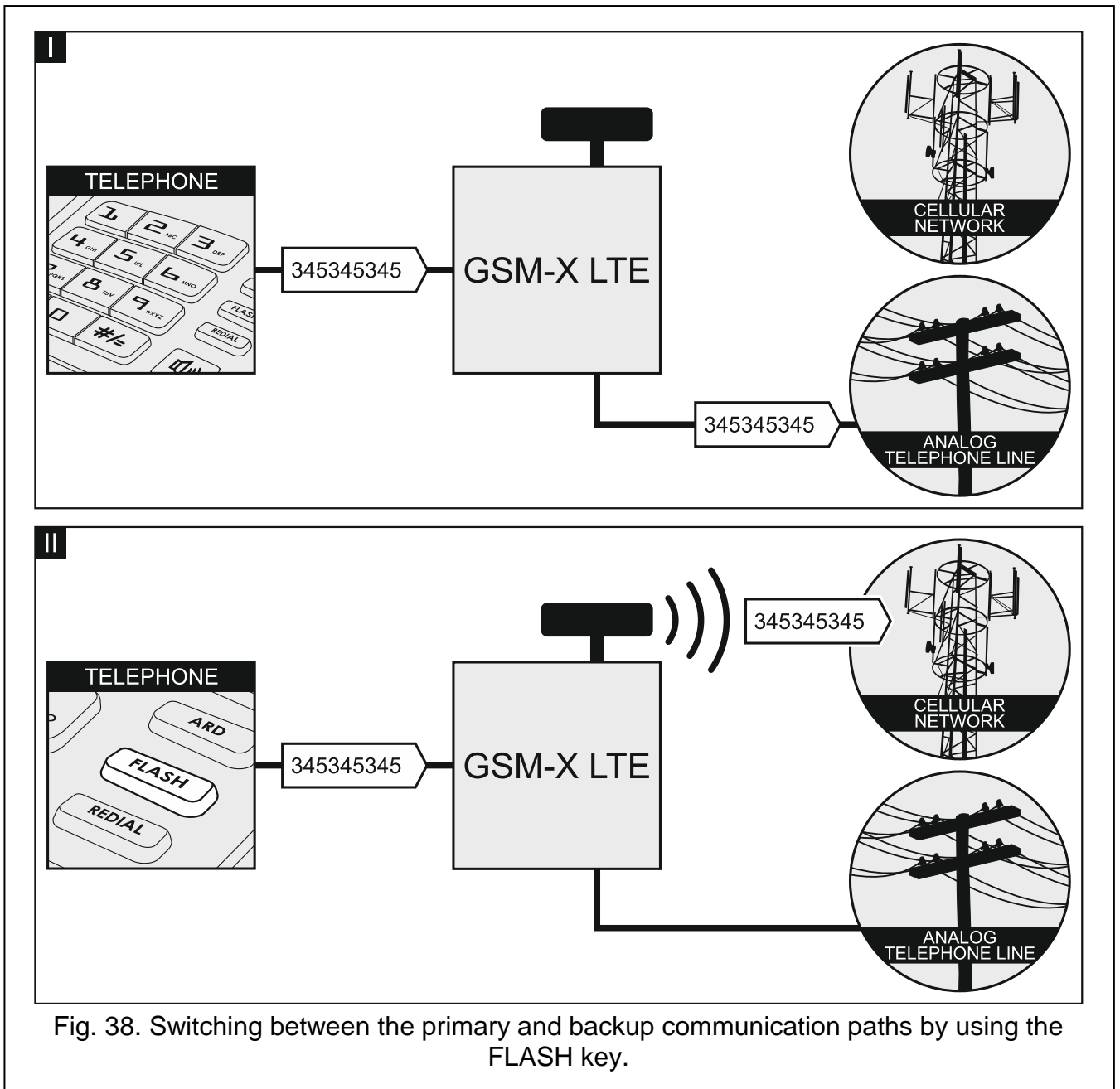

Fig. 38. Switching between the primary and backup communication paths by using the FLASH key.

Switch line if trouble – if this option is enabled, the module will automatically switch over to the backup communication path in case of the primary path trouble.

No voltage on T-1/R-1 if GSM trouble – if this option is enabled, voltage on the telephone line output will be turned off in case of the cellular telephone trouble.

Generate routing signal – if the option is enabled, the connection setup is audibly signaled.

FLASH prefix – a string of up to 16 digits for switching between the primary communication path and the backup one. To set the primary communication path, use the “GSM as a primary telephone line” option. In the example shown in Fig. 39, analog telephone line is used as the primary communication path. If the telephone number the control panel is calling is preceded by a prefix (a string of digits against black background – Fig. 39-II), the backup path will be used i.e. cellular telephone. In the control panel, you must program two pauses after the prefix, before the telephone numbers, by entering two E or F characters.

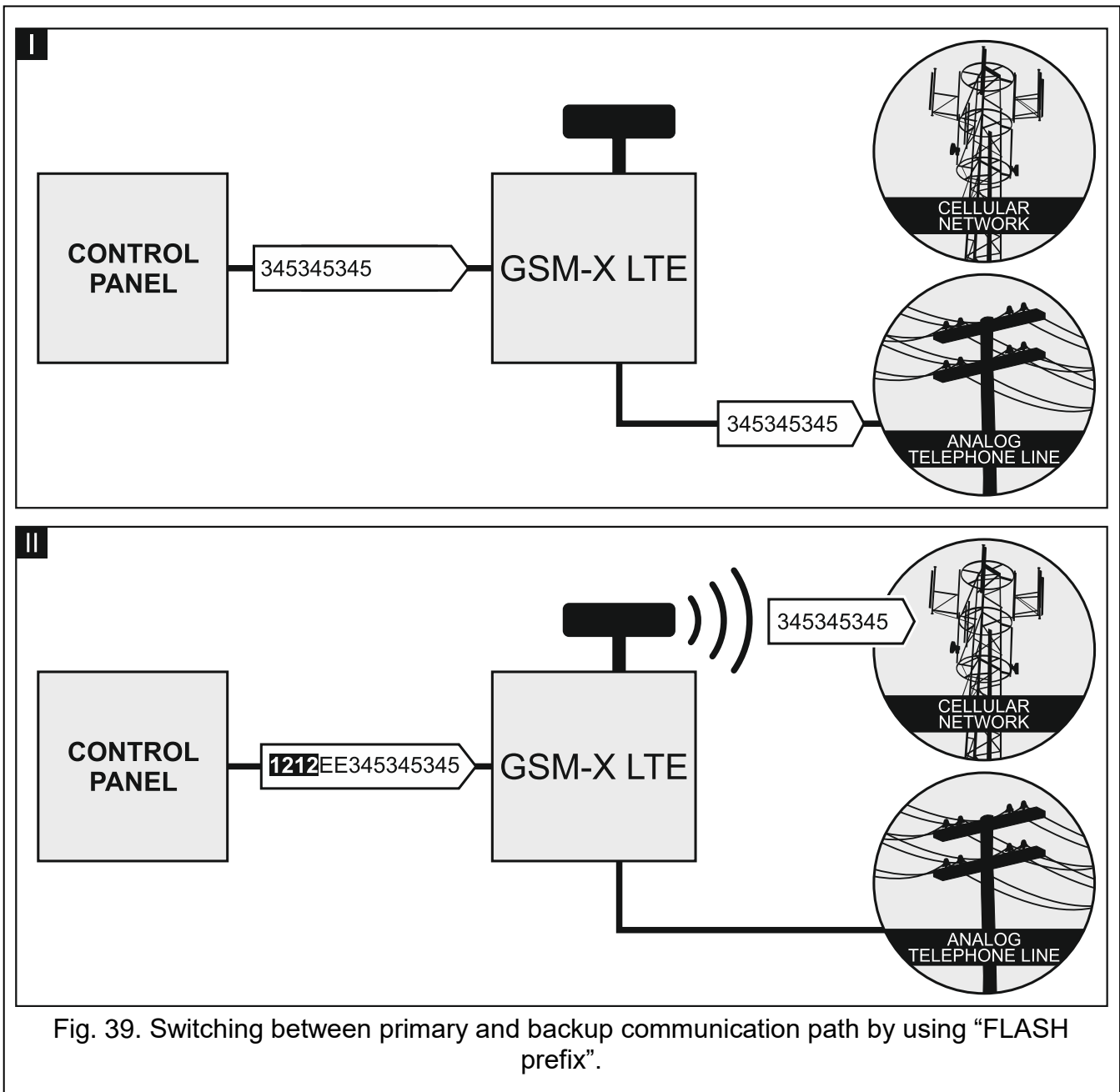

CLIP standard (tel. line) – the module offers the caller identification feature. The following options are available:

- - [function disabled];
- FSK;
- DTMF.

8.9.1 PAGER to SMS conversion

PAGER station number – the number after dialing of which by a device connected to the telephone line output the module will simulate the pager station. The further part of the dialed number will be treated as the cellular telephone number to which the PAGER type message will be sent in the form of SMS message. The pager station number can consist of up to 16 digits.



The programmed number must be unique and must not coincide with any other number programmed in the module.

SMS prefix – a string of up to 16 digits placed before the cellular telephone number to which the SMS message is to be sent. This option allows to add a country code before any telephone number.

8.9.2 PSTN to GSM prefix

Prefix to add – a string of up to 16 digits placed before a telephone number in the case of simulation of analog telephone line by using cellular connection. This option allows to add a country code before any telephone number.

8.9.3 Telephone numbers



The telephone number may contain up to 16 digits.

Outgoing numbers

You can program 4 phone numbers. If the number dialed by the device connected to the telephone line output coincides with the outgoing number, then, after the last digits of the outgoing number are dialed, the module will start converting the digits following the number and, using the cellular telephone, will set up connection to the number entered after the outgoing number.

Allowed tel. numbers

You can program 64 phone numbers from which and which you can call by using the cellular telephone. You can program the whole telephone number (including the country code) or only part of it. Up to five characters (consecutive digits from any part of the number, including “+”) can be treated as part of the number. Six and more characters will be interpreted by the module as the whole telephone number.

8.10 Station simulation

Fig. 40. “Station simulation” tab.

Station simulation – if this option is enabled, the module can receive event codes from a device connected to the telephone line output (the module simulates the monitoring station).

Events buffering – if this option is enabled, each event received by the module from the control panel is written to the module event log and confirmed immediately on receipt. If the option is disabled, events from the control panel will not be written to the module event log, and the received event will only be confirmed after the module receives acknowledgement of the event receipt by the monitoring station.

Reporting format – format in which event codes are sent to the monitoring station. The following formats are supported: SIA, CID, AdemcoExpress, Sil.Knight/Ademco slow, Radionics 1400Hz, Radionics 1400Hz with parity.

Obtain identifier automatically – enable this option, if the control panel identifier is to be used by the module for module's own test transmissions. Enabling this option is not recommended when several identifiers are used by the control panel for reporting purposes (when sending a code of module related event, the identifier used last time by the control panel will be used, which means that events related to the module can be sent with different identifiers).

Replace obtained identifier – enable this option, if the module, after receiving the event code from the control panel and before sending it to the monitoring station, is to replace the identifier in event code with characters programmed in the “Module identifier” field (see: “Reporting” tab p. 46).

Station tel. number – if this number is dialed by the device connected to the telephone line output, the module will be receiving the event codes. If the “Reporting” option (p. 45) is enabled in the module, the received codes can be retransmitted by the module to the monitoring station. To define how they should be sent, select the respective reporting paths – see “Reporting priority” p. 48.



The programmed number must be unique and must not coincide with any other number programmed in the module.

[Kiss-off] – the way of configuring the “Kiss-off time” and “SIA kiss-off delay” parameters.

Custom settings – you can configure the parameters manually.

Typical settings – the parameters are configured automatically, as required by the selected reporting format (“Reporting format”).

[control panel] – the parameters are configured automatically, as required by the selected alarm control panel.

Kiss-off time – duration of the signal generated by the module to confirm receipt of the event from the control panel. The value entered must be suitable for the reporting format selected in the control panel. You can program from 0 to 9999 ms (default: 0 ms). Programming value 0 means that the kiss-off time will be programmed according to the standard of the format selected in the control panel.

SIA kiss-off delay – the time by which the acknowledgment of receipt by the module of the event in SIA format will be delayed. The value entered must be suitable for the control panel settings. You can program from 0 to 9999 ms (default: 0 ms). Programming value 0 means that the time of kiss-off delay will be programmed according to the SIA format standard.

Conversion

For events in Ademco Express and Contact ID format, you can select the following options:

Convert 0 to A in identifier – if this option is enabled, the module will convert 0 into A in the identifier of event sent to the monitoring station.

Convert A to 0 in identifier – if this option is enabled, the module will convert A into 0 in the identifier of event sent to the monitoring station.

Convert 0 to A in event – if this option is enabled, the module will convert 0 into A in the code of event sent to the monitoring station.

Convert A to 0 in event – if this option is enabled, the module will convert A into 0 in the code of event sent to the monitoring station.

Information

Tel. line mode/state – information about current handling of the telephone line output.

Tel. line data – information about the data currently being received from the device connected to the telephone line output.

8.11 Reporting

The module can send event codes to the monitoring station by using the following transmission paths:

- GPRS/LTE (using SIM 1/SIM 2 card),
- SMS messages (module gets no acknowledgement of event code receipt),
- GSM voice channel (the use of this transmission path is not recommended because of distortions that may occur when sending the event codes),
- Ethernet network (optionally, using the GSM-X-ETH module),
- PSTN network (optionally, using the GSM-X-PSTN module).

Connecting the optional GSM-X-ETH / GSM-X-PSTN component to the module enables implementation of Dual Path Reporting in accordance with EN 50136.

i *If the “Events buffering” option is not enabled, events received by the module from the control panel connected to the analog telephone line output have a priority over events generated by the module and their codes are sent to the monitoring station first.*

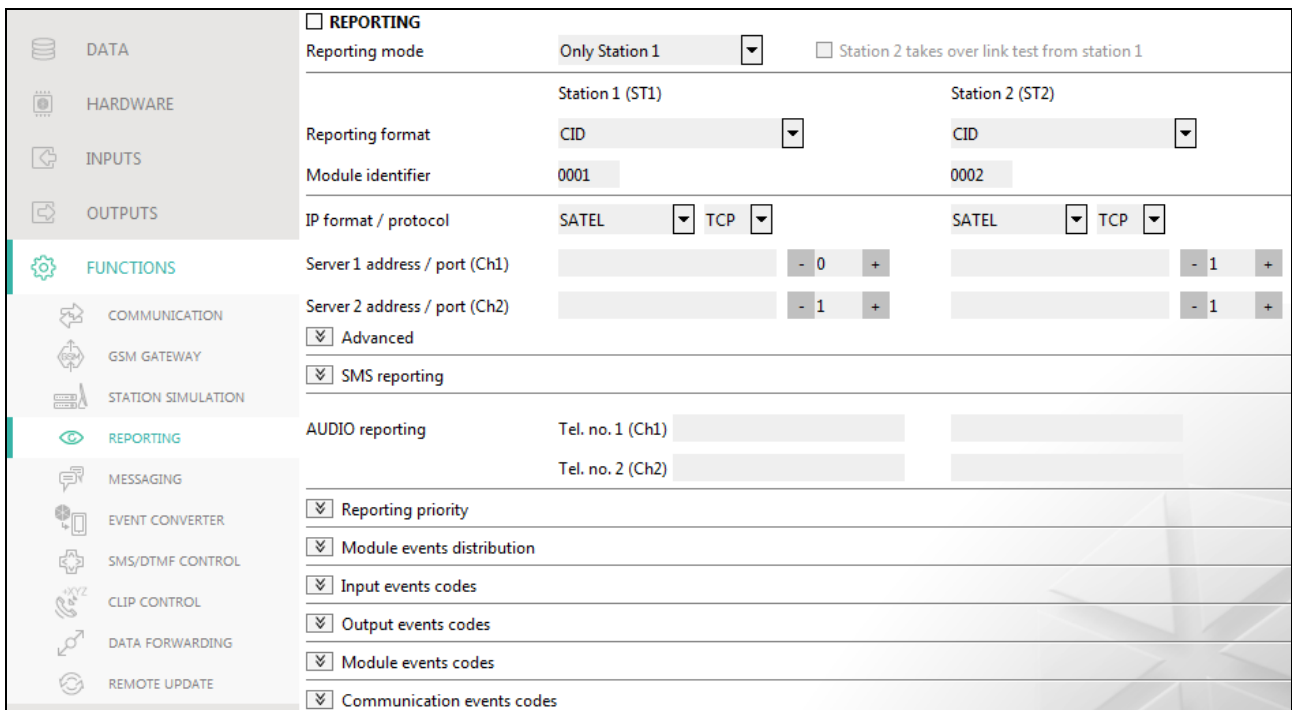

Fig. 41. “Reporting” tab.

Reporting – if the option is enabled, the module can send event codes to the monitoring station. The option applies to the events received by the module from the device connected to the telephone line output and the events generated by the module.

Reporting mode – the way of sending event codes to the monitoring stations:

Only Station 1 – the event codes are only sent to station 1.

Only Station 2 – the event codes are only sent to station 2.

Station 1 and Station 2 – the event codes are sent to both stations (the module must receive acknowledgement of the receipt of the code from both monitoring stations).

Station 1 or Station 2 – the module will make an attempt to send the event code to station 1 and, if unsuccessful, to station 2.

Station 2 takes over link test from station 1 – if this option is enabled when the module fails to connect to the monitoring station 1 during the connectivity test, the module will test connectivity to the monitoring station 2. The option can be enabled if the SIA-IP format is selected for both monitoring stations in the “IP format / protocol” field (see p. 46).

Station 1 (ST1) / Station 2 (ST2)

Reporting format – the format in which event codes are sent to the monitoring station.

The following formats are available: SIA, CID, AdemcoExpress, Sil.Knight/Ademco slow, Radionics 1400Hz, Radionics 1400Hz with parity. If the “Station simulation” option (p. 43) is enabled in the module, the field cannot be edited. If this is the case, information about the format selected in the “Station simulation” tab (see “Reporting format” p. 44) is displayed in the field.

Module identifier – a string of characters that enables the monitoring station to define from where the events are being sent. For the Contact ID format, it consists of 4 hexadecimal characters (digits or letters from A to F). For the SIA format, it consists of 6 hexadecimal characters (digits or letters from A to F).

IP format / protocol – for reporting via cellular network or Ethernet, you must define:

- format: SATEL or SIA-IP (SIA DC-09 standard).
- protocol: TCP or UDP.

Server 1/2 address / port (Ch1)/(Ch2) – in the case of cellular network and Ethernet reporting, enter:

- address of the monitoring station. You can enter either the IP address or the domain name.
- number of the port used for communication between the module and the monitoring station during reporting. You can enter a value from 0 to 65535.

AUDIO reporting

Tel. no. 1 (Ch1) – phone number of the monitoring station for AUDIO reporting via GSM voice channel.

Tel. no. 2 (Ch2) – phone number of the monitoring station for AUDIO reporting via the PSTN network. Reporting via the PSTN network is possible if the GSM-X-PSTN module is installed.

Advanced

SATEL station key – a sequence of characters for encrypting data sent in SATEL format to the monitoring station via cellular network and Ethernet. You can enter up to 12 alphanumeric characters (digits, letters and special characters). If you want to enter 24 hexadecimal characters (digits or letters from A to F), enable the “hex” option.

ETHM/GPRS key – a string of characters, which is used to identify the module for the purpose of cellular network and Ethernet reporting in SATEL format. You can enter up to 5 alphanumeric characters (digits, letters and special characters). If you want to enter 10 hexadecimal characters (digits or letters from A to F), enable the “hex” option.

SIA-IP account number – a string of characters, which is used to identify the module for the purpose of reporting in SIA-IP format. You can enter up to 16 hexadecimal characters (digits or letters from A to F).

SIA-IP key – a sequence of characters for encrypting data sent in the SIA-IP format. You can enter up to 16 alphanumeric characters (digits, letters and special characters). If you want to enter 32 hexadecimal characters (digits or letters from A to F), enable the “hex” option.

Account prefix (L) / Receiver number (R) – a string of characters enabling the module identification scope to be expanded for the needs of reporting in SIA-IP format. You can enter up to 6 hexadecimal characters (digits or letters from A to F).

Both servers link test – if this option is enabled, the module will test connectivity to the two servers of the monitoring station. The option applies to SIA-IP format.

Supervision every – in the case of reporting in the SIA-IP format, an additional transmission can be sent at specified intervals to check link with the monitoring station. You can program a number of days, hours, minutes and seconds between the transmissions. Entering zeros only means that no additional transmission will be sent.

Server 2 takes over link test from server 1 – if this option is enabled when the module fails to connect to the monitoring station server 1 during the connectivity test, the module will test connectivity to the server 2 (according to settings provided for testing the server 1). The option applies to SIA-IP format.

Transmission period acc. to – the way of configuring the “Supervision every (Server 1)” and “Supervision every (Server 2)” parameters.

DP1 / DP2 / DP3 / DP4 – the parameters are configured automatically, as required by the EN 50136-1 standard for Dual Path Reporting.

OTHER – you can configure the parameters manually.

The options are available when the “Both servers link test” option is enabled.

Supervision every (Server 1) / Supervision every (Server 2) – number of days, hours, minutes and seconds between the tests for connectivity to servers. The fields are displayed when the “Both servers link test” option is enabled.

Encrypt – if the option is enabled, the data being sent are encrypted, and additionally the date and time are sent with event code (the monitoring station can program the date and time in the module). Option for SIA-IP format.

Send timestamp – if the option is enabled, the date and time are sent with event code (the monitoring station can program the date and time in the module). Option for SIA-IP format. It is available, when the “Encrypt” option is disabled.

Send MAC address – if this option is enabled when the event codes are sent to the monitoring station over Ethernet, the MAC address is sent together with the event code. Option for SIA-IP format.

SMS reporting

SMS reporting – tel. number – phone number of the monitoring station for SMS reporting.

SMS format – SMS format for SMS reporting. It must be defined as required by the monitoring station. The SMS message format, preset by default in the module, corresponds to the default settings of the STAM-2 monitoring station (firmware version 1.2.0 or newer) for the Contact ID format.



The STAM-2 station and SMET-256 converter do not support SMS messages in SIA format. The form of SMS message sent by the module in SIA format is #ID|CODE, where ID is 4- or 6-character identifier, and CODE is the received event code.

Reporting priority

Reporting priority – if sending an event code to the monitoring station using one transmission path fails, the module can use another transmission path. You must specify the order of using different transmission paths by the module. A successful send of the event code to the monitoring station will terminate the procedure (except for the test transmissions if option “Send test transmissions using all paths” is enabled). For each transmission path, you can define:

Ch1 / Ch2 – if the option is enabled, the module will try to send the event code to the address of the given server. If you select sending to the two addresses, a successful send of event code to the first address will terminate the procedure. An exception is the test transmission if option “Send test transmissions using all paths” is enabled. In such case the module will try to send the event code to both servers.

Timeout – the maximum time during which the module will try to send the event code to selected addresses. If the event code is not sent during that time, the module will switch over to the next address, and then to the next path on the list.

Suspend time – the time for which reporting will be suspended, if attempts fail to send an event code through all provided transmission paths. The module will resume the attempt of establishing connection with the monitoring station after this time expires or a next, new event occurs. Up to 30 minutes can be programmed (by default: 1).

Number of retries – the number of unsuccessful retries to send the event over the given reporting path, after which the module will make an attempt to send the event over the next path. You can program from 1 to 100 (by default: 3).



The module will only use the transmission paths for which priority is specified (they are included in the list defining the order of using transmission paths).

In the case of SMS reporting, the module gets no acknowledgement of receiving the event codes by the monitoring station, hence this transmission path should be used as the last one.

The switch-over from one SIM card to the other one requires time (for example, to log onto the network), so it is better to use up all the transmission paths available for one SIM card.

The switch-over from one SIM card to the other is affected by the “Lock time” and “Return time” (see “GSM” p. 32).

Send test transmissions using all paths – if the option is enabled, test transmission will be sent using all paths for which priority is specified (they are included in the list defining the order of using transmission paths). If the option is disabled, a successful send of event code to the monitoring station using one of the paths will terminate the procedure.

Module events distribution

Define which events are to be sent to the monitoring station 1 and which to the monitoring station 2. The code of a module related event will be sent to the monitoring station only when the box next to the event description is checked. Adjust the distribution of events to the way of sending codes, selected in the “Reporting mode” field (see p. 46).

Input / Output / Module / Communication events codes

You can define event codes that will be sent to the monitoring station for events from the module inputs and outputs and for events related to module and communication. For each event, you can define codes in three formats:

4/2 [Ademco Express, Sil.Knight/Ademco slow, Radionics 1400Hz, Radionics 1400Hz with parity] – enter 2 characters (digits or letters from A to F). The event code must be consistent with the code programmed for the event in the monitoring station.

SIA – select event code consistent with SIA format by using the code editor. To open the code editor, click on the button.

Contact ID – select event code consistent with CID format by using the code editor. To open the code editor, click on the button.

8.12 Messaging

The module can send notifications about events by means of:

- voice messages – the voice messages which are to be used for notification should be saved to the module by using the GX Soft program.
- SMS/push messages – the content of the messages which are to be used for notification should be saved to the module by using the GX Soft program.
- CLIP – the module provides information about event by calling the programmed phone numbers and hanging up automatically after maximum 15 seconds. CLIP provides toll-free messaging capability. The displayed module telephone number should be treated as a notification of event.

Messaging – if this option is enabled, the module can send notifications of module related events.

Managing notifications

Messaging priority – if this option is enabled, when during the telephone connection of device connected to the telephone line output an event occurs which is to be notified by the module, the connection will be terminated. If this option is disabled, the messaging will only be realized when the device connected to the telephone line output completes the call.

Messaging sounds – if this option is enabled, the module will generate a sequence of sounds every 2 seconds during voice messaging to signal the events presented in the table below (where: dot – short sound, dash – long sound).

Event	Tone sequence
Input 1 violation	•
Input 1 restore	– •
Input 2 violation	••
Input 2 restore	– ••
Input 3 violation	•••
Input 3 restore	– •••
Input 4 violation	••••
Input 4 restore	– ••••
Input 5 violation	•••••
Input 5 restore	– •••••
Input 6 violation	••••••
Input 6 restore	– ••••••
Input 7 violation	•••••••
Input 7 restore	– •••••••
Input 8 violation	••••••••
Input 8 restore	– ••••••••

Output 1 ON	• • –
Output 1 OFF	– • –
Output 2 ON	• • – –
Output 2 OFF	– • – –
Output 3 ON	• • – – –
Output 3 OFF	– • – – –
Output 4 ON	• • – – – –
Output 4 OFF	– • – – – –
Telephone line trouble	– – •
Telephone line restore	– – –
Test transmission	– – – –
New external event	– – – •
Reporting trouble	– – – – •
Reporting OK	– – – – –
AC power failure	– – – – – •
End of AC power failure	– – – – –
Battery trouble	– – – – – •
Battery restore	– – – – – –

Test transmission with module status – if this option is enabled, module status information is sent in SMS message to notify of the “Test transmission” event.

Managing voice messages

You can manage voice messages for the events of which the module is to inform the users.



click to open the settings window. In the window, you can select the source from which messages will be recorded or the text-to-speech converter (voice synthesizer) installed on the computer that will be used for text processing.



You can download the Microsoft Speech Platform 11 from the www.microsoft.com website. Installation of the following files is required:

- *SpeechPlatformRuntime.msi* (x86 i.e. 32-bit version),
- *MSSpeech_TTS_xx-XX_yyyy.msi* (where *xx-XX* is language, and *yyyy* is voice).



click to save the voice messages to the module.



click to read the voice messages from the module.



click to convert the message text into a voice message.



click to play back the selected voice message.



click to record the voice message.



click to stop recording / playback of the selected message.



click to import the .WAV file to be used as the voice message for the selected event.



click to delete the selected .WAV type voice message.

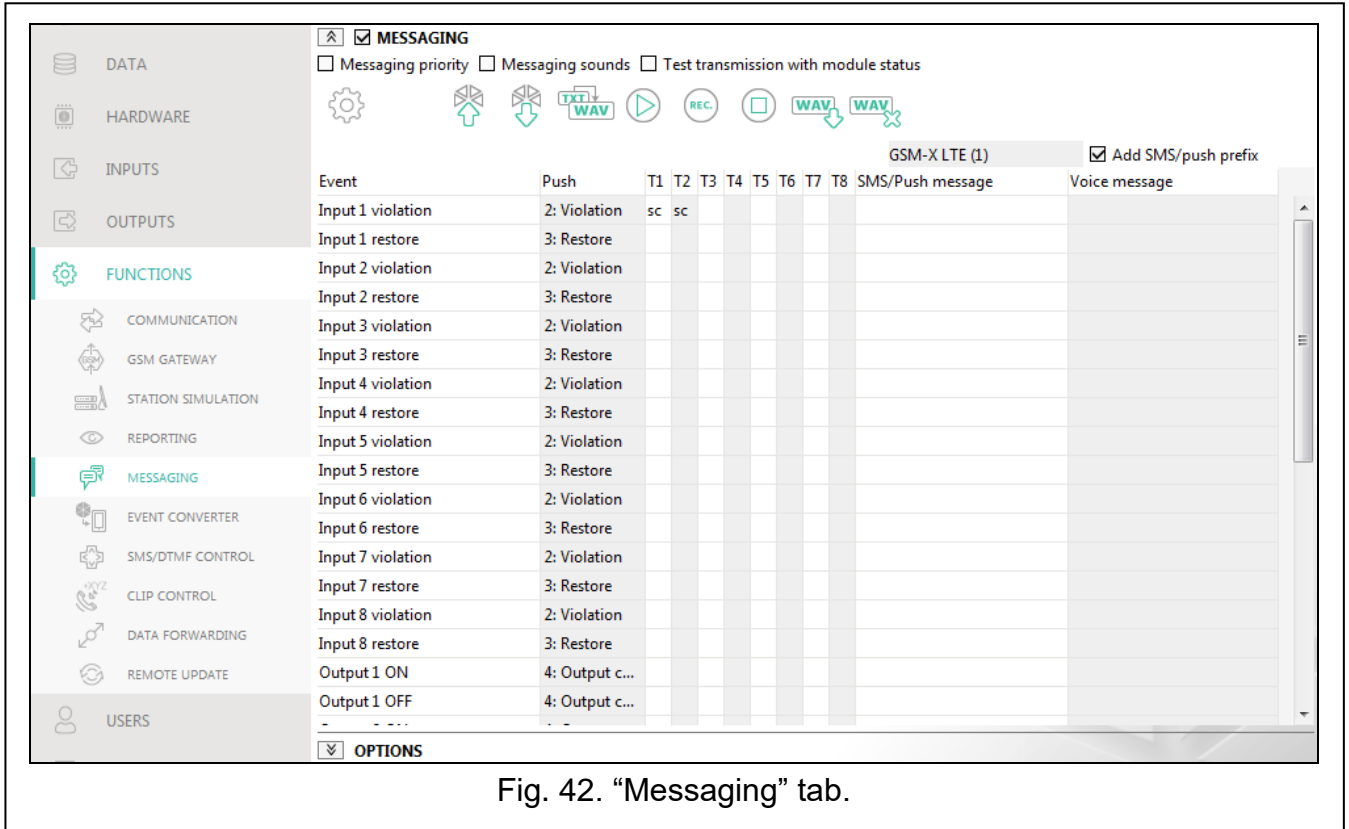

Fig. 42. “Messaging” tab.

SMS prefix

Add SMS/push prefix – if this option is enabled, you can define in the adjacent field a prefix to precede the body of each message sent by the module in the SMS/push notification. The prefix can contain up to 32 characters (digits, letters and special characters).

Event assignment

Event – event description.

Push – event category. You can assign the event to one of the following categories: 1: Alarm / 2: Violation / 3: Restore / 4: Output control / 5: Input block / 6: Diagnostics / 7: Other / 8: Push to all. Double click on the field or enter a digit from 1 to 8.

T1...T8 – messaging method selected for the given telephone (see “Users” p. 60):

- [blank field]** – no notification,
- s** – event notification using SMS,
- c** – event notification using CLIP,
- v** – event voice notification,
- sc** – event notification using SMS and CLIP.

Double click on the field or enter s, c, v or sc to define the method of notification.

SMS/Push message – content of the SMS/push message. The message may contain up to 32 characters.

Voice message – content of the voice message. In order to convert it into the voice message, click the  button. See also “Managing voice messages”.

Options

User – user name (see “Users” p. 60).

Attempts – the number of attempts to send notification by means of CLIP to the given user telephone (see “Users” p. 60). You can enter from 0 to 15 (by default: 3).



If the “Confirmation” option is disabled, the module will make just one call, regardless of the programmed number of attempts.

Confirmation – CLIP – if this option is enabled, receipt of the CLIP message by the given user is to be acknowledged. In order to acknowledge receiving the message, the connection with module must be rejected not earlier than 10 seconds and not later than 20 seconds since the telephone ring is heard. Acknowledgement of receiving the CLIP messaging will make the module stop repeating it.

Confirmation – voice (DTMF) – 4-digit code used in order to acknowledge receiving a voice message. The user can acknowledge receiving a message by entering the code on the telephone keypad after the message has been played back. Acknowledgement of receiving the voice message will make the module stop repeating it.

SMS – if this option is enabled, failure to receive the acknowledgement of CLIP messaging will result in sending to the given user telephone number of an SMS message with content entered for this event.

Clear messaging after confirmation

It is possible to disable sending CLIP / voice notifications to the rest of users after the user has acknowledged receiving the message. Select the telephone numbers which will not be notified after the user has acknowledged receiving the message.

8.13 Event converter

The module can notify the users of events received from the control panel in the form of event code. Notifications can be realized via:

- SMS/push messages – the text of messages to be used for notification must be saved to the module by using the GX Soft program.
- CLIP – the module will inform the users of the event by calling the programmed phone numbers and disconnecting automatically after maximum 15 seconds. CLIP offers toll-free notification. The displayed module telephone number is to be treated as event notification.

You can indicate 32 events of which the module will notify the users.

Event converter – if this option is enabled, the module can notify the users of the events received from the control panel.

Add event details to SMS – if this option is enabled, the number of partition where the event occurred and the number of user or the number of zone that caused the event will be automatically added to the SMS message sent by the module after receiving the event code. The option only applies to event codes in Contact ID format.

Ident. – identifier that must precede the event code so that the module can send notification of the event. For 4/2 or Contact ID format, you can enter 4 characters (digits or letters from A to F). For SIA format, you can enter 6 characters. If you program no identifier, regardless of what kind of identifier is to precede the event code, receiving it will result in sending the message.

Format – format in which the event code must be received so that the module can send notification of the event. You can select: 4/2, Contact ID or SIA. Double click to change the format.

CODE – event code, after receiving of which notification of the event will be sent. For 4/2 format, enter 2 characters (digits or letters from A to F). For Contact ID or SIA format, you can use the code editor. To open the code editor window, click on the button available in the “Event” field.

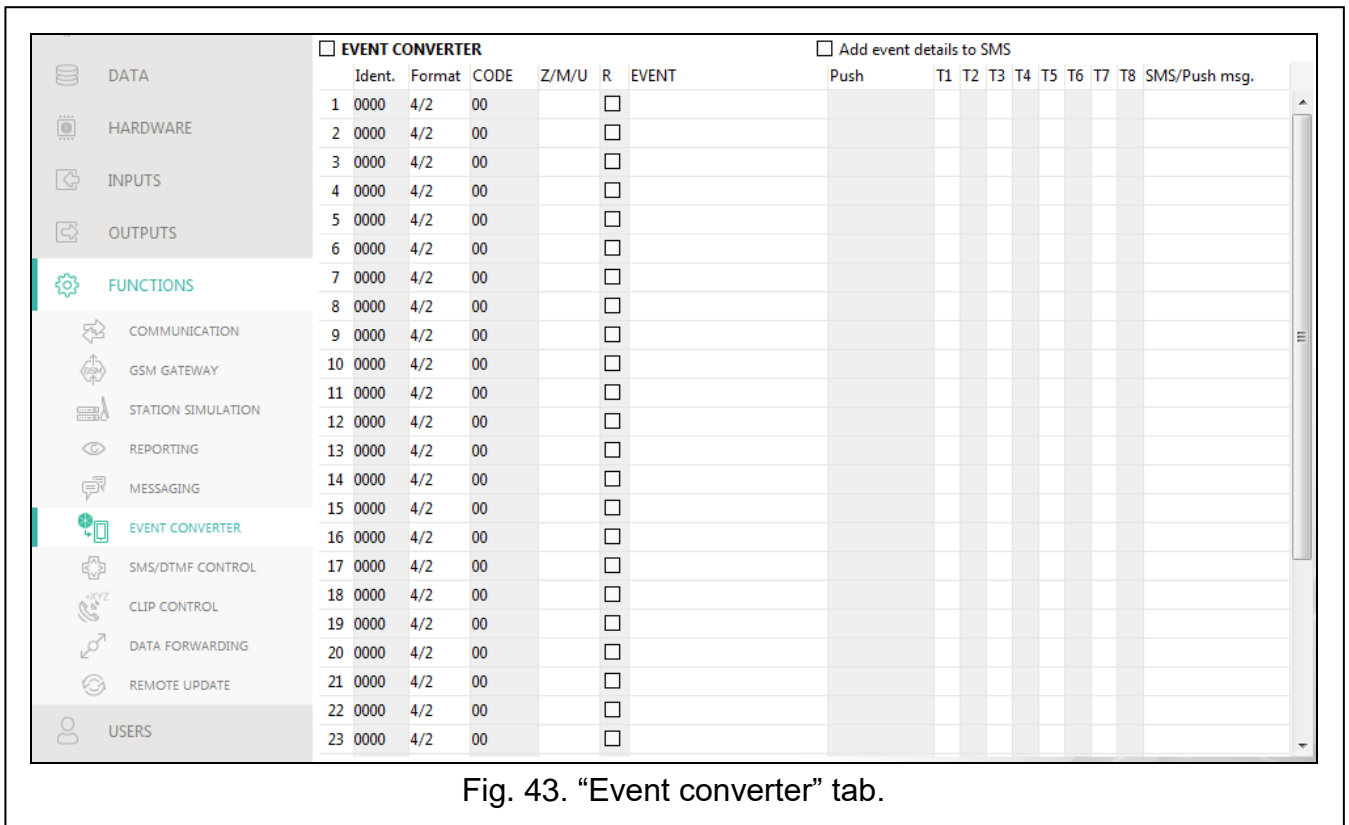

Fig. 43. "Event converter" tab.

Z/M/U – number of zone / module / user that must be included in the received code so that the module can send notification of the event. The field applies to SIA and Contact ID formats.

R – the option applies to Contact ID format. If it is enabled, the received event code refers to event restore / arming. If it is disabled, the received event code refers to a new event.

EVENT – event description. The field refers to SIA and Contact ID formats. It is autocompleted after entering the event code into the "CODE" field.

Push – event category. You can assign the event to one of the following categories: 1: Alarm / 2: Violation / 3: Restore / 4: Output control / 5: Input block / 6: Diagnostics / 7: Other / 8: Push to all. Double click on the field or enter a digit from 1 to 8.

T1...T8 – messaging method selected for the given telephone (see "Users" p. 60):

[blank field] – no notification,

s – event notification using SMS,

c – event notification using CLIP,

sc – event notification using SMS and CLIP.

Double click on the field or enter letter s, c or letters sc to define the messaging method.

SMS/Push msg. – the contents of SMS message which will be sent after receiving the selected event code. The message may be composed of up to 32 characters.

8.14 SMS/DTMF control

You can control the module via SMS messages containing appropriate control commands as well as by using keypad of the telephone (DTMF codes) from which connection to the module was established. The SMS messages must be sent to the number of the SIM card currently in use.

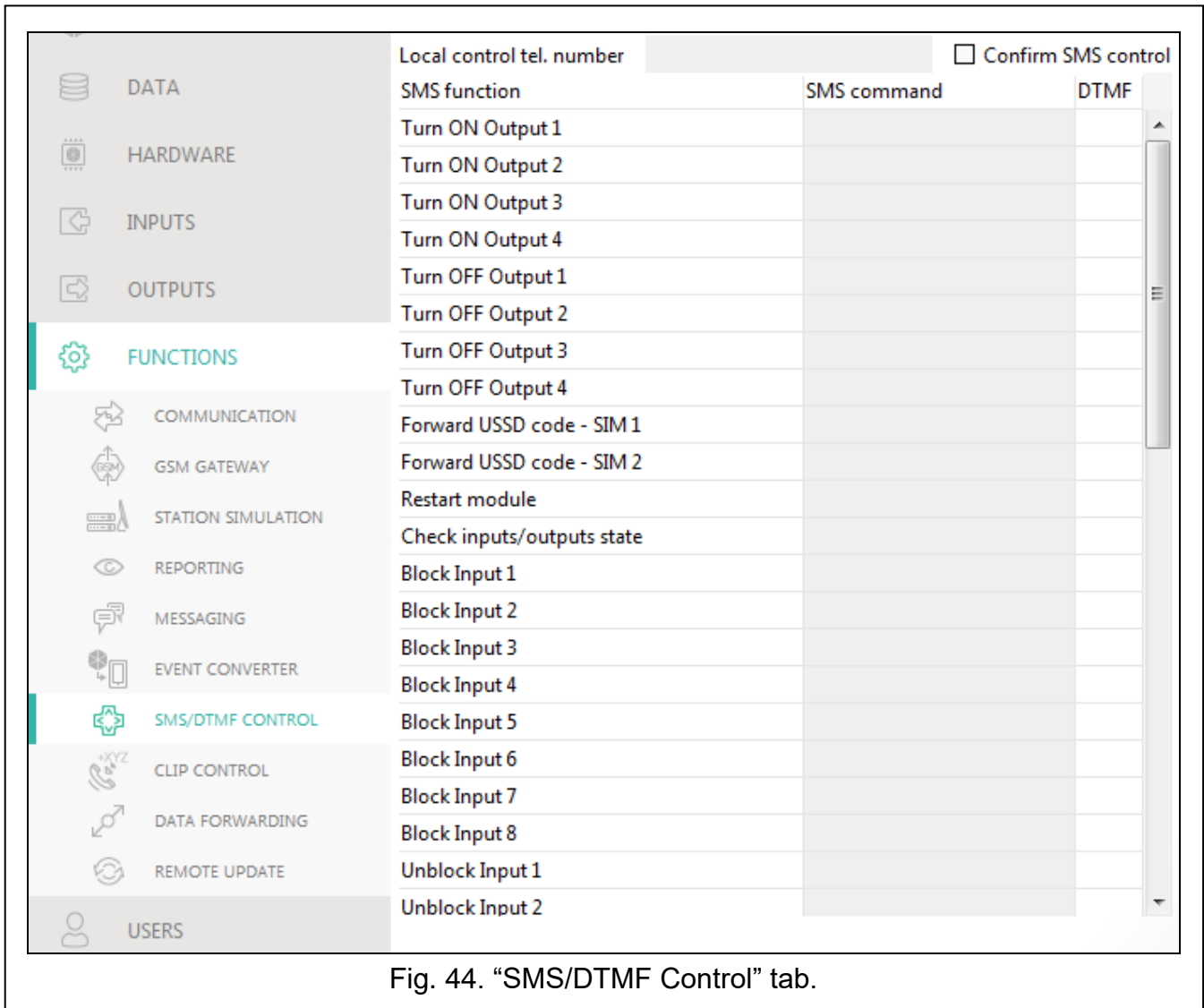

Fig. 44. "SMS/DTMF Control" tab.

Local control tel. number – code triggering the DTMF local control function. You can enter up to 16 digits. Entering the code from the keypad of telephone connected to the telephone line output will allow you to control the module (see p. 64).

Confirm SMS control – if this option is enabled, after receiving an SMS message with control command, the module will confirm the receipt by sending a return SMS message with the module status.

SMS function – function run on receiving the control command / code.

SMS command – the control command which, if sent in the SMS message, will run the function assigned to the command. You can enter up to 16 alphanumeric characters except spaces (digits, letters and special characters). For some functions, the SMS message sent must have a specified form:

Forward USSD code – SIM 1/SIM 2 – allows you e.g. to check the account balance of SIM card installed in the module. The SMS message sent to the module must have the following form: **"xxxxxx=yyyy."** or **"xxxxxx=yyyy="**, where: "xxxxxx" – control command, "yyyy" – USSD code supported by the cellular network operator. The module will use the USSD code contained in the command and will send the reply received from the operator to the telephone number from which the control command was sent.

Change test transmission period – allows you to program the interval after which a test transmission will be sent. The SMS message sent to the module must have the following form: **"xxxxxx=M"** or **"xxxxxx=H:M"**, where: "xxxxxx" – control command, "M" – number of minutes after which the transmission will always be sent, "H:M" – hour

and minute when the transmission will be sent once a day (enter Greenwich Mean Time (GMT)).

Change user 1...8 tel – allows you to program the number of telephone user. The SMS message sent to the module must have the following form: “**xxxxxx=yyyy.**” or “**xxxxxx=yyyy=**”, where: “xxxxxx” – control command, “yyyy” – new number of telephone user. It is recommended that the telephone number be preceded by the country code.



The content of control commands must vary.

The content of one control command must not be inserted into the content of another command.

It is not advisable to use the advanced functions available due to the USSD service if menu is presented in response to the entered code.

*The control command for sending USSD codes can be used for sending SMS messages through the module. The SMS message sent to the module must have the following form: “**xxxxxx=telephone:text=**”, where “xxxxxx” – control command, “telephone” – telephone number to which the SMS message will be sent by the module, “text” – content of the message.*

DTMF – control code that can be entered after establishing connection to the module from telephone keypad to run the selected function. The code must contain 4 digits.



When being sent, the DTMF tones may get corrupted, thus impeding control.

Construction of some telephones requires activation of the DTMF control function.

8.15 CLIP control

You can control the module outputs by using the CLIP service.

Any telephone

You can program how the module outputs are to be controlled by using the CLIP service from any phone number.



The numbers from the “Additional telephone numbers” list and the users' telephone numbers are not treated by the module as any telephone numbers.

Users

You can program how the module outputs are to be controlled by using the CLIP from the users' telephones (see “Users” p. 60).

Additional telephone numbers

You can program how the module outputs are to be controlled by using the CLIP from additional phone numbers.

Telephone number [Filter...] – enter the phone number or part of it to filter the list.

Description [Filter...] – enter the text describing the phone number or part of it to filter the list.

Telephone number – you can program 64 phone numbers to control the outputs by using CLIP. You can program the whole telephone number (including the country code) or only part of it. Up to five characters (consecutive digits from any part of the number, including “+”) can be treated as part of the number. Six and more characters will be interpreted by the module as the whole telephone number.

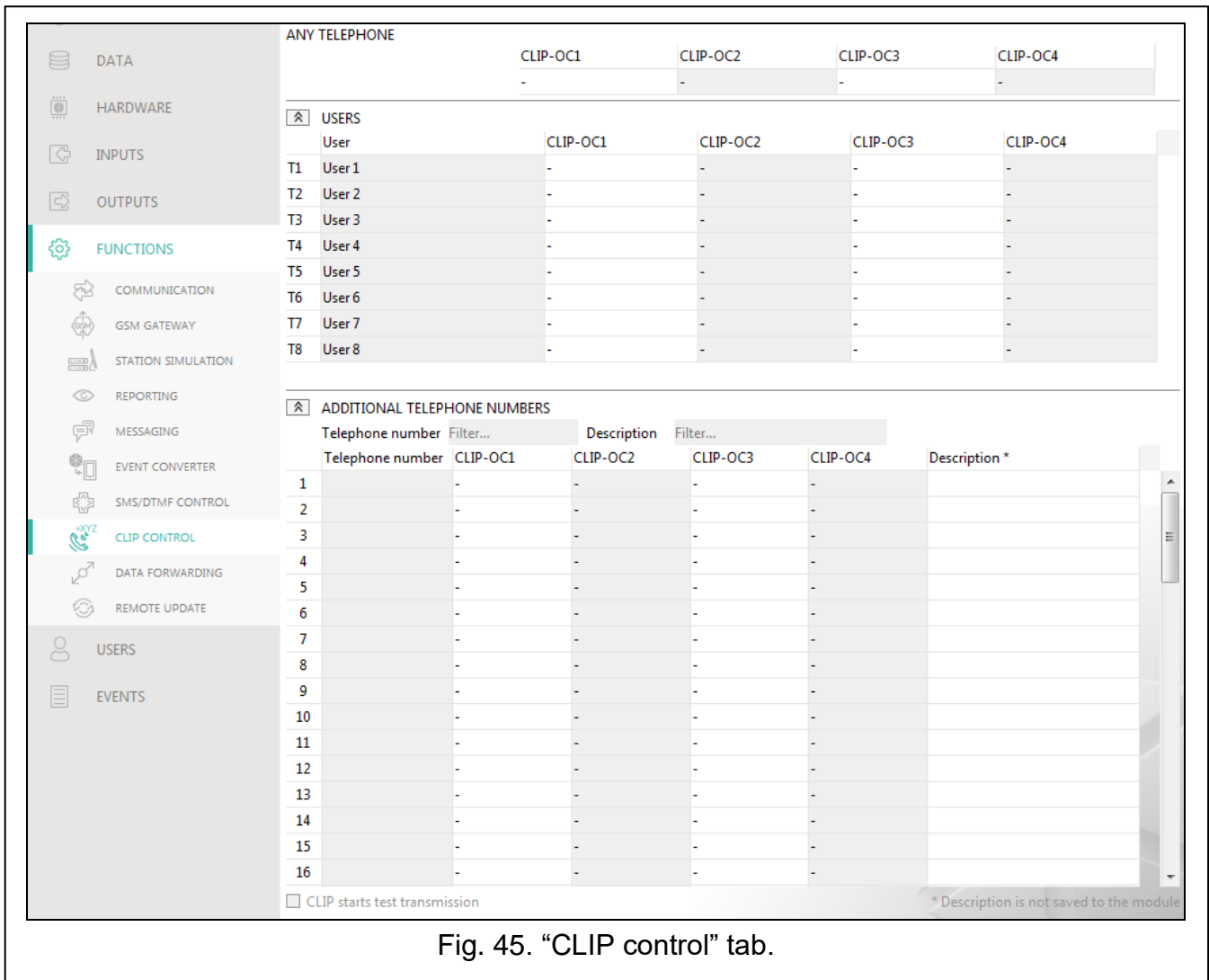

Fig. 45. "CLIP control" tab.

Description – you can enter description of the given telephone number. The description may contain up to 32 characters (digits, letters and special characters). The description is not saved to the module.

Output control

CLIP-OC1...OC4 – the output can respond to CLIP in one of the following ways:

-- CLIP does not control the output.

1: ON – CLIP will turn on the output.

2: OFF – CLIP will turn off the output.

3: ON FOR TIME – CLIP will turn on the output for a specified period of time (see "Operating time" parameter p. 37).

4: TOGGLE – CLIP will switch the output to its opposite state.

If several different responses to CLIP from one telephone number are programmed for the given output (e.g. OC1) (when the number or part of it is programmed in two or more rows of the table), then in response to CLIP from that number the output will be switched over successively to each of the programmed states. The switching sequence will correspond to the consecutive numbers from the telephone list.

You can sort the data in the table. If you click on the selected column header (e.g. "Telephone number"), the table will be sorted by the data in that column. The symbol indicating the current sorting method (^ – ascending, v - descending) will be displayed in the column header.

CLIP starts test transmission – information about additional reaction of the module to CLIP. If the option is enabled, a test transmission will be additionally started by the module in response to CLIP. You can enable/disable this option in the “Mainboard” tab (see “CLIP starts test transmission” p. 32).

8.16 Data forwarding

The module can make connections between the INTEGRA / INTEGRA Plus control panel (connected to the module through RS-232 port) and the computer with GUARDX or DLOADX program installed.

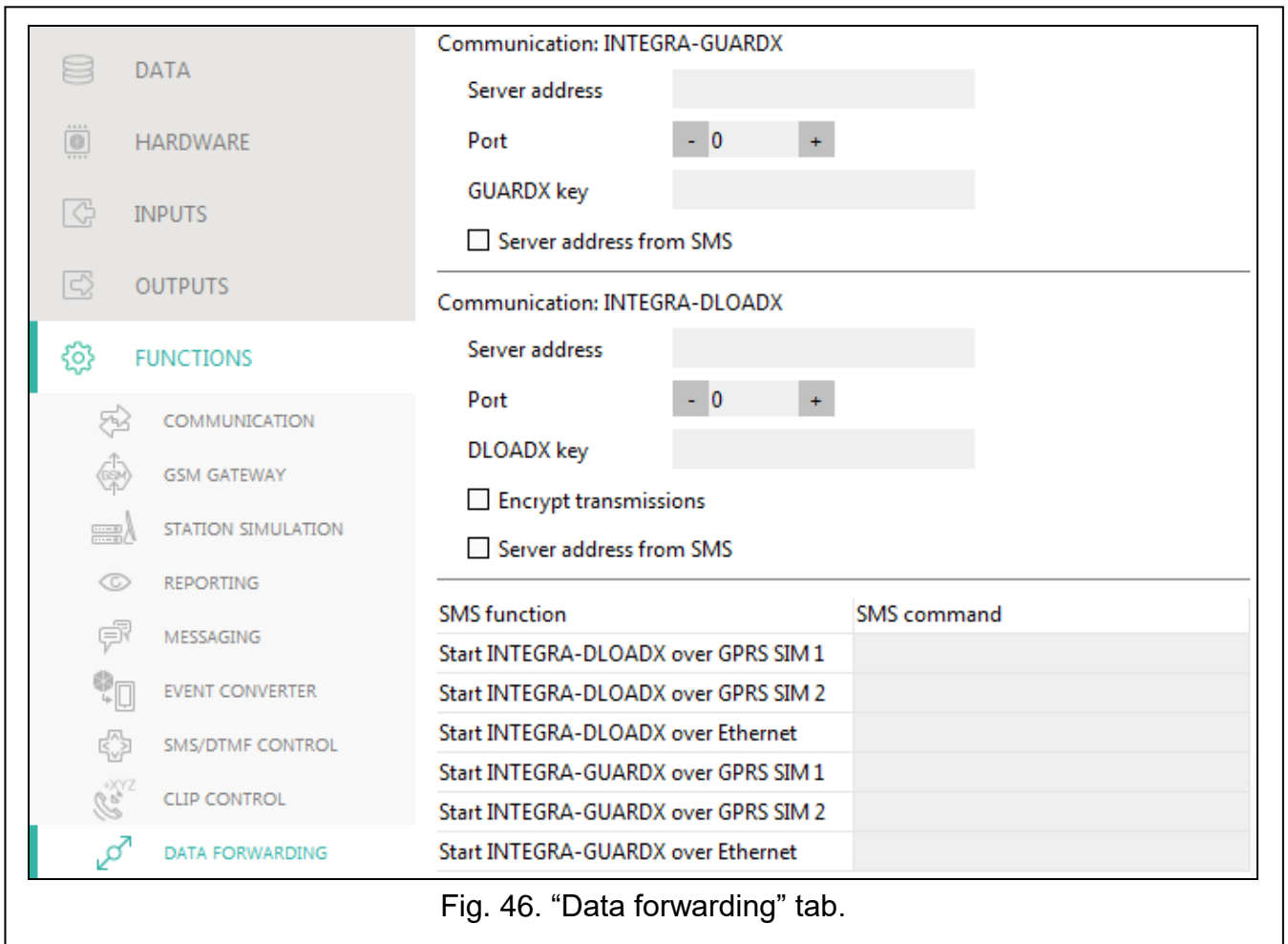

Fig. 46. “Data forwarding” tab.

Communication: INTEGRA – GUARDX

Server address – the address of the computer with the GUARDX program, with which the module (connected to the INTEGRA / INTEGRA Plus control panel through RS-232 port) is to communicate using the TCP/IP communication protocol (cellular network or Ethernet). You can enter the IP address or domain name.

Port – the number of port on which the communication with the GUARDX program will take place.

GUARDX key – the string of 12 alphanumeric characters (digits, letters and special characters) used for data encryption during communication with GUARDX program. The module will only establish connection to the program using the correct key.

Server address from SMS – if this option is enabled, the address of computer with GUARDX program and the port number can be entered in the SMS message that initiates the connection. If the message contains no address or port number, the module will use the preprogrammed settings.

Communication: INTEGRA – DLOADX

Server address – the address of the computer with the DLOADX program, with which the module (connected to the INTEGRA / INTEGRA Plus control panel through RS-232 port) is to communicate using the TCP/IP communication protocol (cellular network or Ethernet). You can enter the IP address or domain name.

Port – the number of port on which the communication with the DLOADX program will take place.

DLOADX key – the string of 12 alphanumeric characters (digits, letters and special characters) used for data encryption during communication with DLOADX program. The module will only establish connection to the program using the correct key.

Encrypt transmissions – if this option is enabled, the data transfer between module and program will be encrypted. The option must be enabled.

Server address from SMS – if this option is enabled, the address of computer with DLOADX program and the port number can be entered in the SMS message that initiates the connection. If the message contains no address or port number, the module will use the preprogrammed settings.

SMS

SMS function – function run after receiving the control command. The functions are used to establish communication between the INTEGRA / INTEGRA Plus control panel and the DLOADX / GUARDX program via the module.

SMS command – the control command which, if sent in the SMS message, will initiate communication with the GUARDX / DLOADX program by using the TCP/IP communication protocol (cellular network or Ethernet). You can enter up to 16 alphanumeric characters except spaces (digits, letters and special characters).



The content of control commands must vary.

The content of one control command must not be inserted into the content of another command.

You can include in the SMS message the address of computer the module is to connect to, and the number of TCP port to be used for communication.

8.17 Remote update

Remote update of the module firmware is made possible by the “UpServ” update server, which is included in the SATEL product portfolio.

Remote update – if this option is enabled, remote update of the module firmware is possible. If the option is disabled, the module firmware can only be updated locally (see “Local update” p. 68). If you select one of the available channels in the “Download update over” field, the option will be enabled automatically.

Update server – address of the “UpServ” update server. You can enter the IP address or domain name.

Port – number of the TCP port used for communication with the “UpServ” update server. You can enter values from 0 to 65535 (0=disabled).

Check for update – you can select how often the module will check for a new firmware version: Never, Everyday, Once per week or Once per month.

Download update over – you can select the channel that will be used to download updates from the server:

GPRS – cellular network. The default channel, selected automatically if the “Remote update” option is enabled.

GSM-X-ETH/GPRS – Ethernet network or cellular network. Ethernet has priority. Cellular network will be used if there is no communication over the Ethernet network.

GSM-X-ETH – Ethernet network.

Selecting the channel will automatically enable the “Remote update” option (if it is disabled). Communication via the Ethernet network is possible if the GSM-X-ETH module is installed.

 – click to start remote firmware update.

Update server address in SMS – if this option is enabled, you can enter server address and port number in the SMS message initiating the firmware download from the update server. If the message contains no address or port number, the module will use the preprogrammed settings.

Check for update after restart – if this option is enabled, the module will connect to the update server after each restart and check if a new firmware version is available.

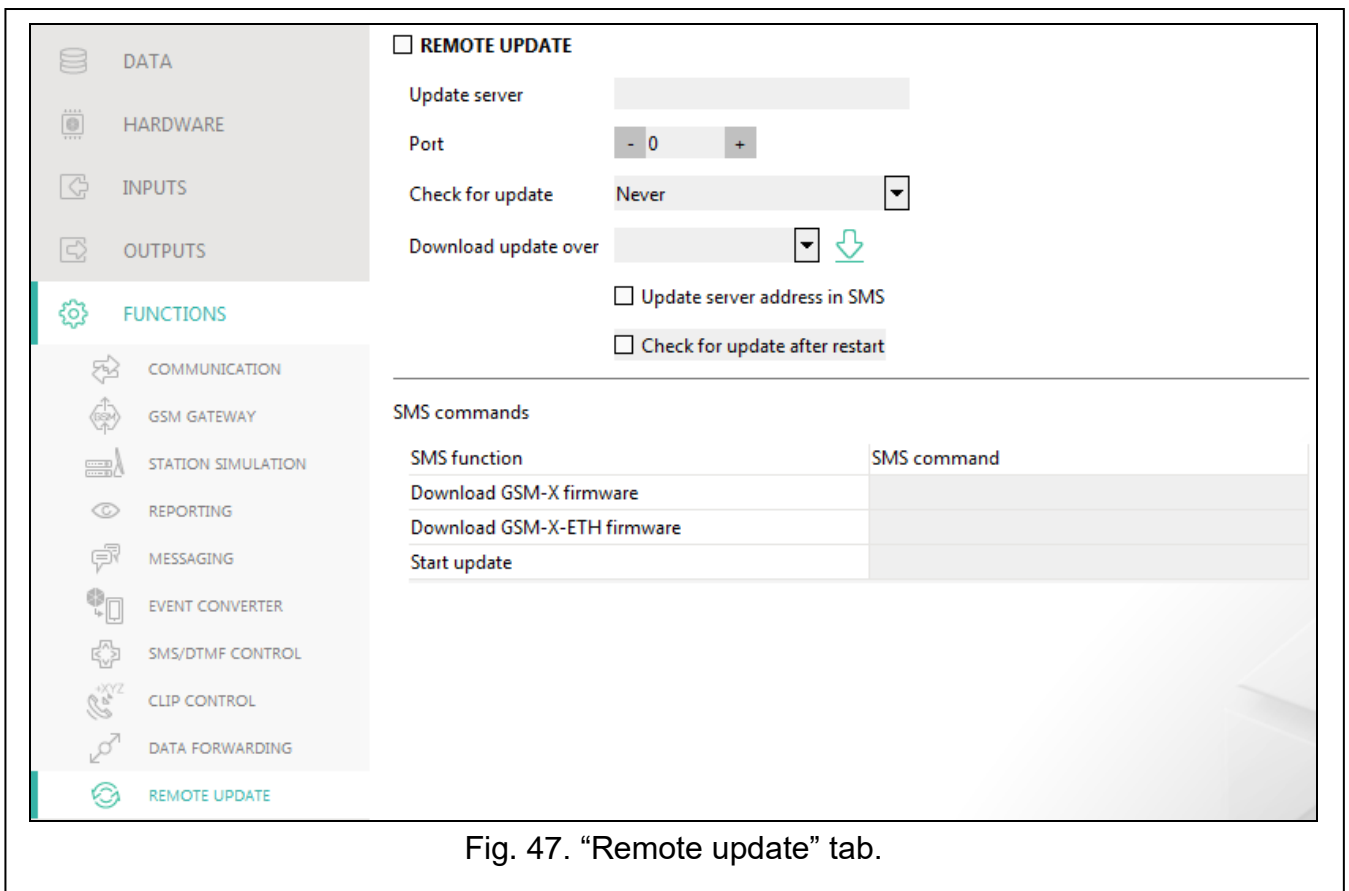



Fig. 47. “Remote update” tab.

SMS commands

SMS function – function run after control command is received. The functions are used for remote update of the module.

SMS command – the control command which, if sent in the SMS message, will start the function. You can enter up to 16 alphanumeric characters except spaces (digits, letters and special characters).

 *The content of control commands must vary.*
The content of one control command must not be inserted into the content of another command.
If you program the command initiating firmware download without programming the command that initiates update of the firmware, the update will start automatically after the download is completed.

8.18 Users

You can enter data of 8 users. It will be possible to control the module from the user telephone number by using SMS messages, DTMF codes (see p. 53), CLIP (see p. 55) and through the GX Control application (see p. 61). At the same time, the module can send notifications (SMS, CLIP and AUDIO) of the events (see p. 49) to the user telephone number.

	User	Telephone number	Forward SMS
T1	User 1		<input type="checkbox"/>
T2	User 2		<input type="checkbox"/>
T3	User 3		<input type="checkbox"/>
T4	User 4		<input type="checkbox"/>
T5	User 5		<input type="checkbox"/>
T6	User 6		<input type="checkbox"/>
T7	User 7		<input type="checkbox"/>
T8	User 8		<input type="checkbox"/>

Fig. 48. "Users" tab.

User – individual name of the user (up to 16 characters).

Telephone number – the user telephone number. You can program the whole telephone number (including the country code) or only part of it. Up to five characters (consecutive digits from any part of the number, including "+") can be treated as part of the number. Six and more characters will be interpreted by the module as the whole telephone number.

Forward SMS – if this option is enabled, unknown SMS messages received by the module are forwarded to the user phone number (e.g. information received from the cellular network operator).

8.19 Events

Up to 500 events generated by the module or received from the control panel can be recorded in the module non-volatile memory.

Clear module event log – click to clear the module event log.

Refresh – click to refresh the list of events.

Events are shown sorted by time in descending order (the latest UP, the oldest DOWN). Individual columns present the following information:

No. – consecutive event number.

Date – date the event occurred in the module / event from the control panel was saved to the module memory (see "Events buffering" p. 44).

Time – hour the event occurred in the module / event from the control panel was saved to the module memory (see "Events buffering" p. 44).

Description – event description (for events in Contact ID or SIA format).

Source – name of source that generated the event.

Station 1 / Station 2 – reporting status:

[blank field] – event is not reported,

. – event waiting to be sent to the monitoring station,

+ – test transmission sent to the monitoring station,

- – sending test transmission has failed,

* – sending event cancelled (e.g. reporting has been disabled),

[name of reporting path] – event sent successfully to the monitoring station using the given transmission path.

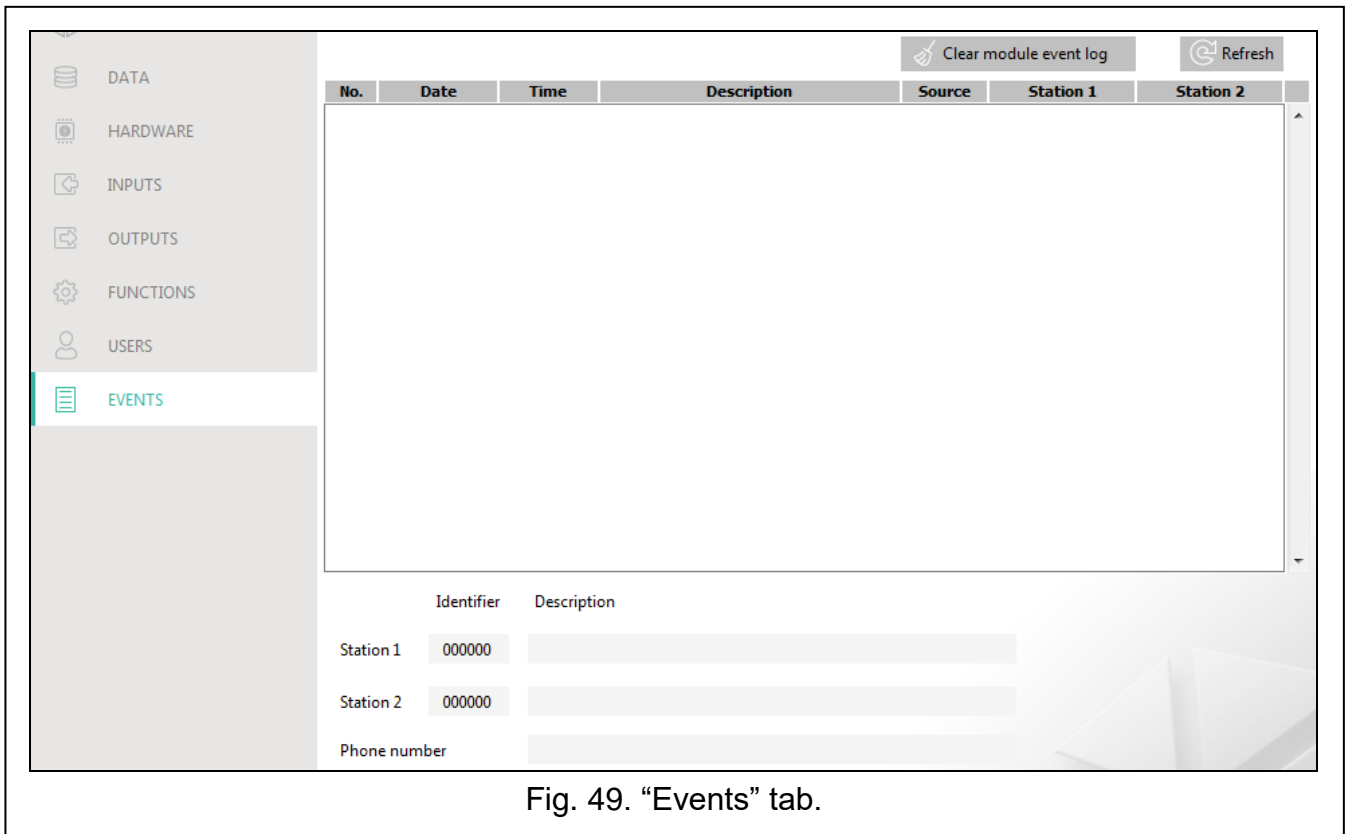

Fig. 49. “Events” tab.

9. GX Control application

The GX Control is a mobile application that allows you to remotely operate GSM-X, GSM-X LTE, GPRS-A and GPRS-A LTE:

- check the status of inputs and outputs,
- block / unblock the inputs,
- control the outputs,
- view the troubles,
- view the event log.

Additionally, the application can provide information on the events by using push notifications.

Communication between the application and the module is encrypted.



Number of the telephone with GX Control application must be programmed in the module in the list of users' telephones (see “Users” p. 60).

You can download the application from the internet stores: “Google play” (Android system devices) or “App Store” (iOS system devices).

When the application is run for the first time, a prompt is displayed asking you whether access to the application is to be password protected. After you define the application access rules, a tutorial will be displayed to prompt you what to do to configure settings for communication with the module. For a new module, the settings can be configured automatically, or you can enter them manually. Fig. 50 shows the GX Control screen that allows you to select how the communication settings are to be configured.

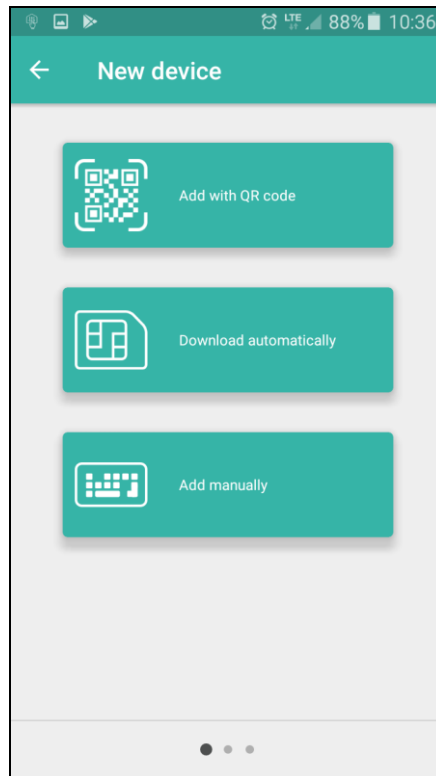

Fig. 50. GX Control application (Android system): select how to configure the settings for a new module.

Add with QR code

Pressing the button will start the QR code scanner to enable communication settings to be read from the QR code (see p. 29).

If the communication settings are configured on one mobile device, they can be easily copied to another mobile device. Just display the QR code on the device in which the settings for communication with the given module are already configured, and read the code on another device.

Download automatically

Pressing the button will display a window in which you are to enter the cellular telephone number of a new module. Communication settings will be downloaded automatically from the module.

Add manually

Allows you to manually configure the settings for communication with the module. Pressing the button will display a window (Fig. 51), in which you must:

- enter the module name (to enable identification of the module when using the application),
- enter the IMEI number of the module cellular communicator (the individual identification number of the cellular telephone),
- enter the module ID number (the individual identification number for the purpose of communication via the SATEL server – see “Project” p. 29),
- enter the user phone number (number programmed in the module – see “Users” p. 60),
- select the icon (to facilitate identification of the module when using the application).

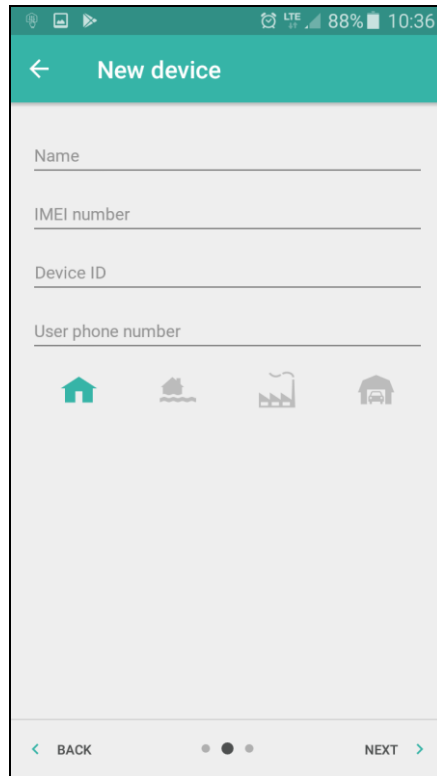

Fig. 51. GX Control application (Android system): manual configuration of new module settings.

10. Control by using a telephone

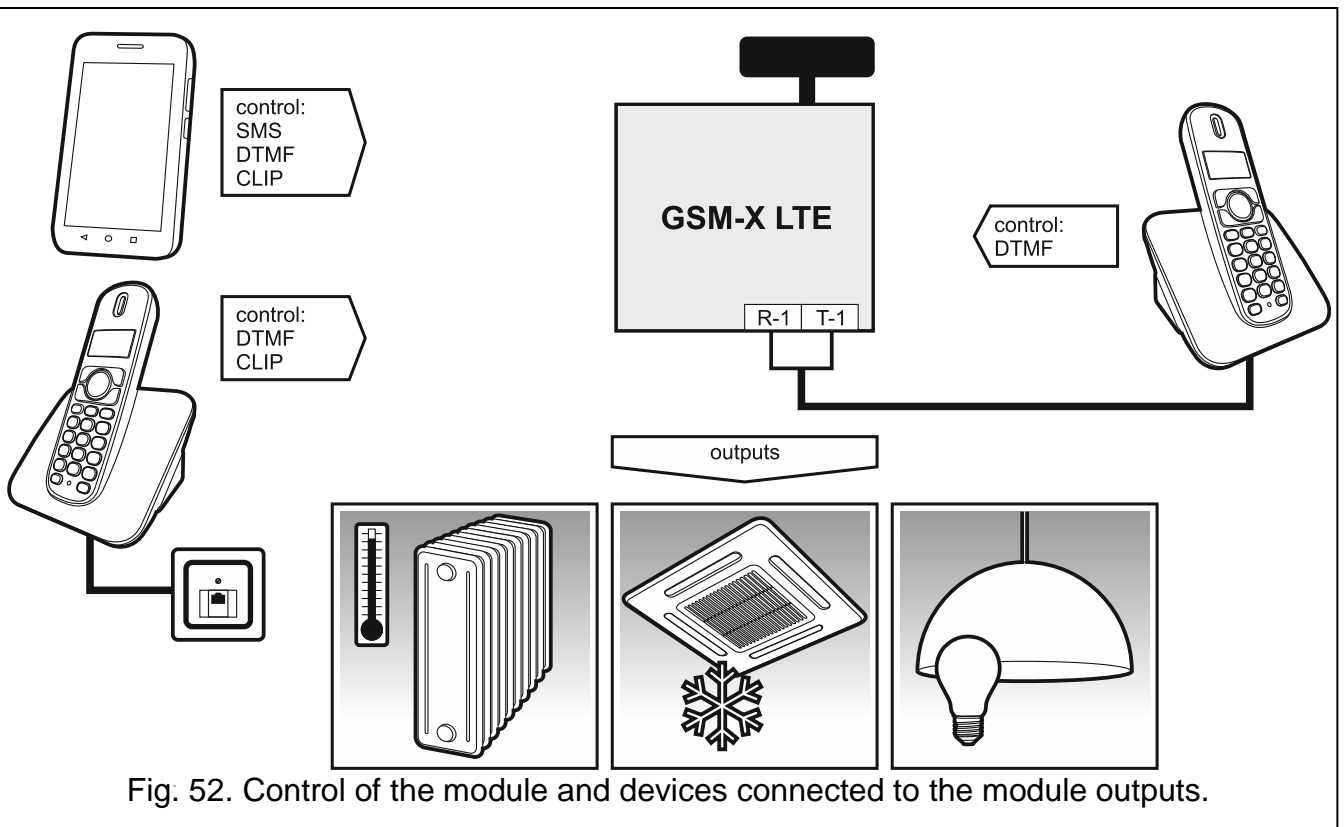

Fig. 52. Control of the module and devices connected to the module outputs.

10.1 Control from the telephone connected to output telephone line

Required settings

- Program the code starting local control of the module (up to 16 digits, see “Local control tel. number” p. 54).
- Program the DTMF control codes for individual control functions (see “DTMF” p. 55).

Control

1. Pick up the receiver and use the telephone keypad to enter the code starting the local module control. The module will generate 2 short beeps to confirm correctness of the code.
2. Enter the control code from the telephone keypad.
3. If the function starts, you will hear 2 short beeps. If the function does not start, you will hear 1 long beep.
4. Repeat the step 2 if the control is to be continued.
5. Hang up to end the control.

10.2 Control from other telephones

10.2.1 From the keypad

Required settings

- Program the “Ringing time” parameter (p. 31).
- Program the control commands (see “SMS/DTMF control” p. 53).
- If the control availability is to be limited to the telephones whose numbers:
 - have been programmed in the module for users (see “Users” p. 60) – enable the “Users tel. numbers” option (p. 32);
 - are on the list of allowed numbers (see “Allowed tel. numbers” p. 43) – enable the “Allowed tel. numbers (GSM Gateway)” option (p. 32).

Control

1. Call the cellular module telephone number.
2. After hearing 2 short beeps, enter the 4-digit control code.
3. If the function starts, you will hear 2 short beeps. If the function does not start, you will hear 1 long beep.



If you make a mistake when entering the control code, press the [] or [#] key and re-enter the code. Entering a wrong code three times will result in loss of connection with the module.*

4. Enter the next control codes or terminate the connection.

10.2.2 Using SMS

Required settings

- Program the control commands (see section “SMS/DTMF control” p. 53).
- If the control availability is to be limited to the telephones whose numbers:
 - have been programmed in the module for users (see “Users” p. 60) – enable the “Users tel. numbers” option (p. 32);
 - are on the list of allowed numbers (see “Allowed tel. numbers” p. 43) – enable the “Allowed tel. numbers (GSM Gateway)” option (p. 32).

- If module is to confirm execution of the control command by means of SMS message, program SMS center number (see “SMS center number” p. 33) and enable the “Confirm SMS control” option (p. 54).

Control

1. Send the SMS message containing a control command to the telephone number of the cellular module.



The control command may be just a fragment of the SMS message, but it must be among the first 32 characters. This makes it possible to write the control command, including the comments, to the telephone memory and send the whole to the module.

Several control commands may be included in one SMS message (should be separated by spaces).

2. If the “Confirm SMS control” option (p. 54) is enabled, after execution of the command the module will send an SMS message with the information on module status:

“OT=????, IN=????, LT=?, SIG=?, ??:?? / ??d??h??m, T1=??, T2=??, T3=??, T4=??, T5=??, T6=??, T7=??, T8=??,”

where:

OT – information on output status [o – output OFF; O – output ON].

IN – information on input status [i or t – input in normal state; I or T – input violated; b – input blocked].

LT – information on telephone line status [ok – the telephone line OK; ?? – telephone line trouble].

SIG – actual level of signal received by antenna [digits from 0 to 4].

??:?? / ??d??h??m – information on every how many days, hours and minutes the module sends the test transmission [once a day at e.g. 15:10 / number of days (d), hours (h) and minutes (m)].

T1...T8 – information on the user telephone numbers programmed in the module.

10.2.3 Using CLIP

Using the CLIP you can only control the status of outputs.

Required settings

- Program the “Ringing time” parameter (p. 31).
- Enter the telephone numbers from which control of the outputs will be possible by means of CLIP (see section “CLIP control” p. 55).
- Define from which telephone numbers and how the outputs are to be controlled by CLIP (see “CLIP-OC1...OC4” p. 56).

Control

Call the module cellular telephone number and hang up after hearing the ring signal. The module will change the output state. If the “Send SMS with module state on CLIP” option (p. 32) is enabled in the module, the module will send an SMS with module state information to your telephone number.

11. Reporting events when the module is used with INTEGRA / INTEGRA Plus

If the INTEGRA / INTEGRA Plus control panel is to report events via the GSM-X LTE module:

1. RS-232 ports of the control panel and the GSM-X LTE module must be connected together.
2. Enable the following options in the control panel:
Reporting - GPRS,
Answering - modem,
Tone dialing,
No dial tone test,
No answer test,
External modem,
Modem ISDN/GSM/ETHM.
3. Configure the following reporting parameters in the control panel:
Reporting format,
Server – enter: gsm-x,
Identifiers.



For detailed information on how to configure the control panel, please refer to the control panel programming manuals.

12. Converting the PAGER type messages into SMS messages

If connected to a device with PAGER type message sending capability, the module can convert the PAGER type messages into SMS messages.

1. Enter the SMS center number, unless it has been written by the operator to the SIM card memory (see “SMS center number” p. 33).
2. Program the number of pager station (see “PAGER station number” p. 42).
3. You can program a country code which will be placed before the cellular telephone number to which the SMS message is to be sent (see: “SMS prefix” p. 43).

12.1 Working in conjunction with the DT-1 dialer

In the DT-1 dialer:

1. Program the signal parameters for the paging system station according to Table 1.

DT-1	C	1	2	2	A	0	E	0	0	7	A	8
-------------	---	---	---	---	---	---	---	---	---	---	---	---

Table 1. Parameters of the paging station signal for the DT-1 dialer.

2. Program the other parameters required to start the PAGER type messaging (see DT-1 dialer manual).

13. Sending SMS messages from the telephone connected to telephone line output

The module makes it possible to send SMS messages from the landline telephone set, generating the DTMF signals, connected to the telephone line output.

The module can work in 2 modes:

1. Numeric mode:

- pressing any telephone key from 0 to 9 means entering the corresponding digit into the message;
- pressing the [*] key twice means switching over to the text mode.

2. Text mode:

- three letters correspond to each numeric key (see: Fig. 53);
- pressing the key means entering the middle letter;
- pressing in turn the numeric key and [*] means entering the letter on the left-hand side of the given key;
- pressing in turn the numeric key and [#] means entering the letter on the right-hand side of the given key;
- pressing the [0] key means entering a space;
- pressing in turn the [0] and [*] keys means entering a dash;
- pressing the [1] key means entering a dot;
- pressing in turn the [0] and [#] keys means switching over to the numeric mode.

The message will be sent on pressing the [#] key when the module is in the numeric mode.

In order to send an SMS message:

1. Lift the receiver of the telephone connected to the telephone line output.
2. Dial the pager station number programmed in the module (see “PAGER station number” p. 42), and then the telephone number to which the SMS message is to be sent. The number should be dialed as soon as possible, without time gaps between the successive digits.
3. Two beeps will be generated by the module to acknowledge the number, if correctly received. No acknowledgement or a busy signal mean a dialing error and the necessity to restart the procedure (to make it easier, you can use the “Redial” key).
4. Enter the message according to the above described rules.



The SMS message sent from a landline telephone set can contain up to 62 alphanumeric characters.

Hanging-up when the text is being entered will terminate the SMS message sending process.

Q . Z 1	A B C 2	D E F 3
G H I 4	J K L 5	M N O 6
P R S 7	T U V 8	W X Y 9
*	– _ 0	#

Fig. 53. Assignment of alphanumeric characters to telephone keypad.

14. The rules for converting the numbers

If the calls are realized by the module cellular telephone, the telephone number received from the control panel or a traditional telephone set is subjected to conversion still before being sent over to the module cellular telephone.

1. When dialing the number, the module first checks if its initial digits are consistent with:
 - the monitoring station telephone number (see p. 44) – the number conversion is not applicable,
 - the number of telephone for DTMF control from a locally connected telephone set (see p. 54) – the conversion applies to the digits following the DTMF control number,
 - FLASH prefix (see p. 41) – the conversion applies to the digits following the prefix,
 - the pager station number (see p. 42) – the conversion applies to the digits following the pager station number,
 - one of the programmed outgoing numbers (see p. 43) – the conversion applies to the digits following the outgoing number.
2. 4 seconds after dialing the last digit, the module proceeds to converting the number. The module checks if it is on the list of allowed telephone numbers (see p. 43). If the number is on the list or the “GSM accepts any tel. number” option (p. 40) is enabled – the number is considered correct and the module will make the connection.

15. Module firmware update



When the firmware update is running, the module does not execute its normal functions.

Before the firmware update, make sure the module settings have been saved to a configuration file.

15.1 Local update

1. Download the update program for GSM-X LTE module firmware from www.satel.eu.
2. Connect the module USB MINI-B socket with the computer USB port.
3. Run the update program for module firmware.
4. Click on the  button.
5. When a prompt window is displayed asking you whether to continue the firmware update, click “Yes”. The firmware of module will be updated. If the GSM-X-ETH module is installed, its firmware will be updated too.

15.2 Remote update

1. Program the parameters for remote update of the module firmware in the module (see “Remote update” p. 58).
2. Initiate the update from the GX Soft program (see p. 59) or by using an SMS message.

15.2.1 Initiating the update by using SMS message



The SMS messages which initiate the download and update of firmware can only be sent from an authorized telephone number (see “Tel. numbers verification (SMS/DTMF control and answer to CLIP)” p. 32).

1. Send to the number of SIM card used by the module an SMS message containing control command to initiate firmware download from the “UpServ” update server (see “SMS command” p. 59). If the “Update server address in SMS” option is enabled in the module and you want the module to connect to an update server other than that indicated in the module settings, the message should look like this: **xxxx=aaa:pp=** (“xxxx” – control command; “aaa” – server address (IP address or domain name); “pp” – port number).
2. Completion of the new firmware download will be indicated by the module with an SMS message.
3. Send an SMS message containing the control command to initiate the module firmware update (see “SMS command” p. 59). If the update initiating control command has not been programmed in the module, the firmware update process will be started automatically by the module after the download is completed.
4. Completion of the module firmware update will be indicated by the module with an SMS message.



If any errors in the module firmware make its update impossible, enter the starter mode to update the firmware (see description of RESET pins p. 12).

16. Restoring the factory settings

1. Click on the “Data” tab in the GX Soft program.
2. Click on “Factory settings” button. You will be prompted whether to restore the factory settings.
3. Click on “Yes”.

17. Specifications

GSM-X LTE

Number of inputs	8
Number of outputs	4
OC type	4
power supply.....	1
Supply voltage	12 VDC ±15%
Standby current consumption	170 mA
Maximum current consumption	520 mA
OC type outputs.....	50 mA / 12 VDC
AUX output	300 mA / 12 VDC
Environmental class according to EN50130-5	II
Operating temperature range.....	-10...+55°C
Maximum humidity.....	93±3%
Electronics board dimensions.....	141 x 70 mm
Enclosure dimensions.....	126 x 158 x 46 mm
Weight.....	269 g

GSM-X-ETH

Standby current consumption	25 mA
Maximum current consumption	25 mA
Environmental class according to EN50130-5	II

Operating temperature range	-10...+55°C
Maximum humidity	93±3%
Electronics board dimensions	61 x 51 mm
Weight.....	25 g

GSM-X-PSTN

Standby current consumption	20 mA
Maximum current consumption	45 mA
Environmental class according to EN50130-5	II
Operating temperature range	-10...+55°C
Maximum humidity	93±3%
Electronics board dimensions	61 x 51 mm
Weight.....	25 g

18. Manual update history

Manual version	Introduced changes
09/20	<ul style="list-style-type: none"> • Section “Introduction” has been updated (p. 4). • Section “Features” has been updated (p. 4). • Section “Typical module applications” has been updated (p. 6). • Section “Electronics board” has been updated (p. 12). • Description of LED indicators on the RJ-45 connector has been modified (p. 19). • Section “GSM-X-PSTN telephone module” has been added (p. 20). • Description of “GSM-X-ETH/PSTN firmware version” field has been modified (p. 30). • Description of “SMS center number” field has been modified (p. 33). • Description of “GSM-X-ETH/PSTN” option has been modified (p. 35). • Description of “ETH/PSTN trouble” option has been modified (p. 38). • Section “Reporting” has been updated (p. 45). • Description of “Tel. no. 2 (Ch2)” field has been modified (p. 46). • Description of “T1...T8” fields has been modified (p. 51). • Description of “T1...T8” fields has been modified (p. 53). • Description of “SMS command” field has been modified (p. 54). • Description of the control command for sending SMS messages via the module has been added (p. 55). • Specifications for “GSM-X-PSTN” module have been added (p. 70).